





TRIUMPH
Foosball Table
Assembly Instructions



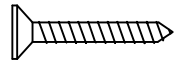
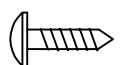
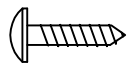
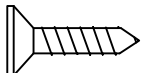
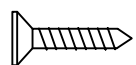

PARTS IDENTIFIER

HARDWARE

	DESCRIPTION	QTY. REQUIRED <small>(EXTRA PIECES MAY BE INCLUDED)</small>
	H1 5/16"x1-1/4" BOLT	16
	H2 5/16" WASHER,	16
	H3 1-1/8" FLAT HEAD PHILLIPS SCREW	24
	H4 1/2" ROUND HEAD PHILLIPS SCREW	100
	H5 5/8" ROUND HEAD PHILLIPS SCREW (Chromium)	18
	H6 SCREW (used to install handle)	8
	S1 5/8" FLAT HEAD PHILLIPS SCREW	24

ACCESSORIES





		QTY
	A1 SOCCER BALL	6
	A2 TOOL	1

ASSEMBLY INSTRUCTIONS

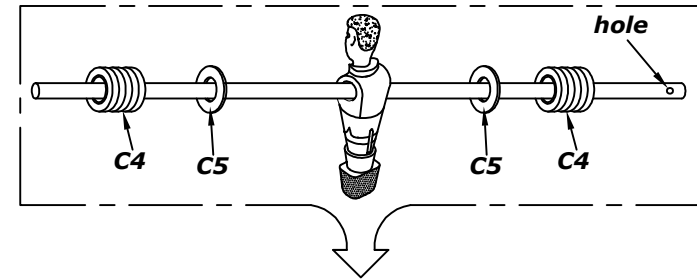
SOCCER TABLE ASSEMBLY

WARNING: TWO ADULTS NEEDED TO ASSEMBLE SOCCER TABLE

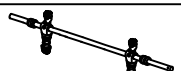

	R1 5 HOME PLAYERS ROD	1
	R2 3 HOME PLAYERS ROD	2
	R3 2 HOME PLAYERS ROD	1
	R5 5 AWAY PLAYERS ROD	1
	R6 3 AWAY PLAYERS ROD	2
	R7 2 AWAY PLAYERS ROD	1

ASSEMBLY INSTRUCTIONS

SOCCER TABLE ASSEMBLY

WARNING: TWO ADULTS NEEDED TO ASSEMBLE SOCCER TABLE

11. INSERT THE PLAYER RODS **C1&C2&C3** THROUGH ONE SIDE PANEL, THEN INSERT PLAYERS **C8&C9**, RUBBER BUSHINGS **C4**, PLASTIC WASHERS **C5** THROUGH THE ROD, THEN INSERT THE PLAYER ROD THROUGH OTHER SIDE PANEL, ATTACH THE PLAYERS **C8&C9** WITH BOLTS **C6** AND NUTS **C7**. SEE **Figure 6**.
12. SLIDE THE HANDLES **P7** ONTO THE ENDS OF THE RODS WITH **H6**. SLIDE THE RUBBER CAPS **P8** ON THE OTHER END OF THE ROD. ATTACH CUP HOLDER **P16** WITH SCREWS **H5**.

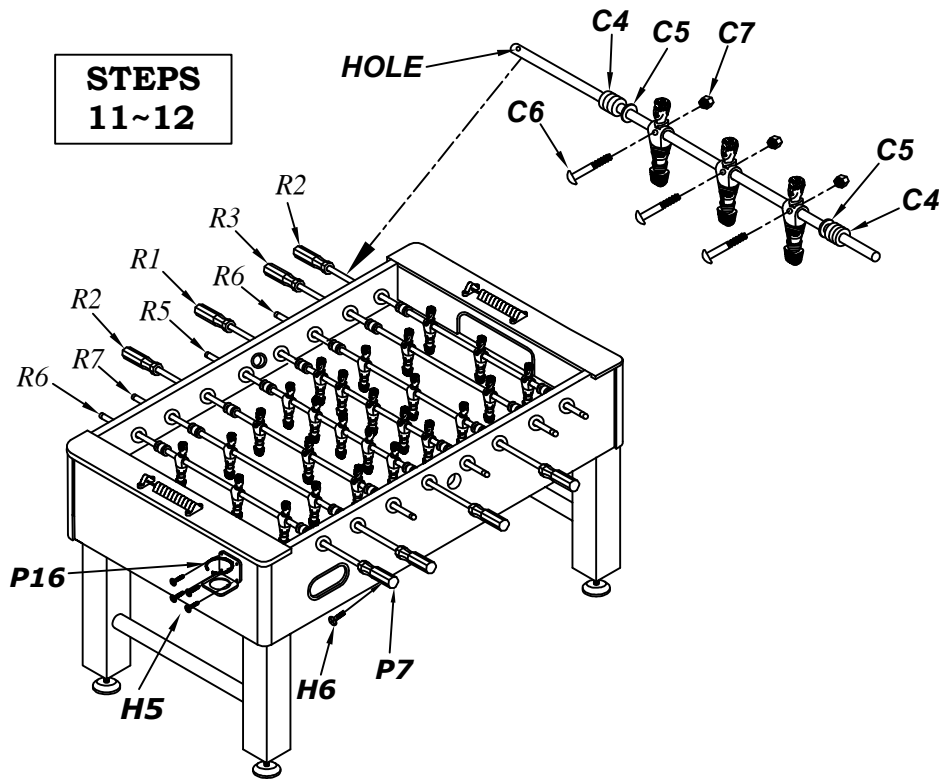



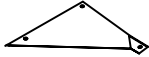

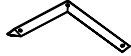
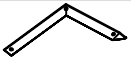
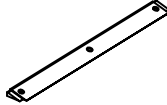
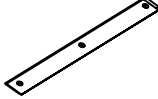

FIGURE 6









PARTS IDENTIFIER

ASSEMBLY PARTS

	DESCRIPTION	QTY
	P1 SIDE PANEL	2
	P2A END PANEL A	2
	P2B END PANEL B	2
	P2C END PANEL C	2
	P3 PLAYING FIELD	1
	P4A LEG A	2
	P4B LEG B	2
	P5 PLAYFIELD SUPPORT BRACE	3
	P6 BRACKET	4
	P7 HANDLE	8
	P8 ROD END CAP	8
	P9A BALL ENTRY CUP	2
	P9B BALL ENTRY SOCKET	2
	P10 LEG LEVELER	4
	P11 BALL CATCHER	2
	P12 GOAL	2
	P13 BALL RUNNER	2
	P14 SLIDE SCORER	2
	P15 CROSS BAR	2
	P16 CUP HOLDER	2

	P17	CORNER	4
	P20	SUPPORT BRACKET	6
	P21	END PANEL BRACKET	8
	#1a	TRIANGLE a	2
	#1b	TRIANGLE b	2
	#2a	L STYLE PLASTIC a	2
	#2b	L STYLE PLASTIC b	2
	#3a	LONG PLASTIC a	2
	#3b	LONG PLASTIC b	2

REPLACEMENT PARTS

	DESCRIPTION	QTY
	C1 5 PLAYER ROD	2
	C2 3 PLAYER ROD	4
	C3 2 PLAYER ROD	2
	C4 RUBBER BUSHING	16
	C5 PLASTIC ROD WASHERS	16
	C6 BOLT(used to install men)	26
	C7 LOCKING NUT (used to install men)	26
	C8 HOME MEN	13
	C9 AWAY MEN	13

ASSEMBLY INSTRUCTIONS

SOCCKER TABLE ASSEMBLY

WARNING: TWO ADULTS NEEDED TO ASSEMBLE SOCCER TABLE

- 9 ATTACH BALL ENTRY CUPS **P9A** AND BALL ENTRY SOCKET **P9B** TO THE SIDE PANELS WITH SCREWS **H5** AS SHOWN IN **figure 5**. ATTACH THE TWO SETS OF SLIDE SCORER **P14** TO THE END OF TABLE WITH SCREWS **H5**.
- 10 ATTACH THE PLASTIC **#2a, #2b, #3a, #3b**, TO THE PLAYING FIELD WITH **S1** AS SHOWN IN **Figure 5**.

STEPS
9.10.

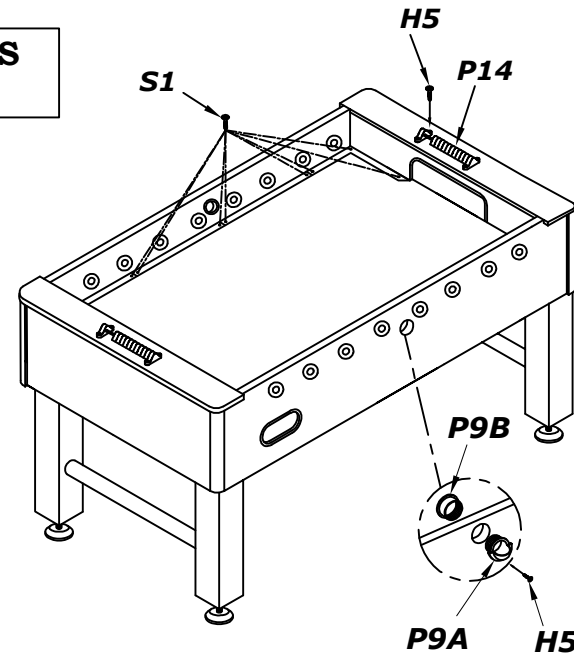
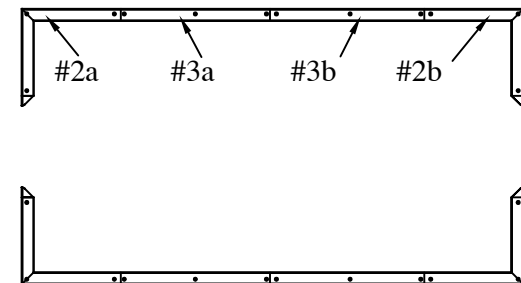

FIGURE 5

Play surface
TOP VIEW



ASSEMBLY INSTRUCTIONS

SOCCKER TABLE ASSEMBLY

WARNING: TWO ADULTS NEEDED TO ASSEMBLE SOCCER TABLE

- 6 INSERT CROSS BAR **P15** INTO LEGS AS SHOWN IN **FIGURE 4**. ATTACH THE LEGS **P4A&P4B** AS SHOWN IN **figure 4**. THE LEGS ARE ATTACHED WITH BOLTS **H1** AND WASHERS **H2**. *TIGHTEN HARDWARE AT THIS TIME!
- 7 PLACE THE GOAL **P12** OVER THE HOLE IN THE END PANEL AND ATTACH USING SCREWS **H4**. PLACE THE BALL CATCHER **P11** OVER THE HOLE IN THE SIDE PANEL AND ATTACH USING SCREWS **H4**. SECURE THE BALL RUNNER **P13** BETWEEN EACH GOAL AND BALL CATCHER. SEE **figure 4**. (REPEAT ABOVE STEP FOR OTHER END OF TABLE)
- 8 ATTACH THE LEG LEVELERS **P10** AS SHOWN IN **figure 4**.

WARNING

This step requires two adults!

Very carefully turn the table over and set on its legs. Be careful!

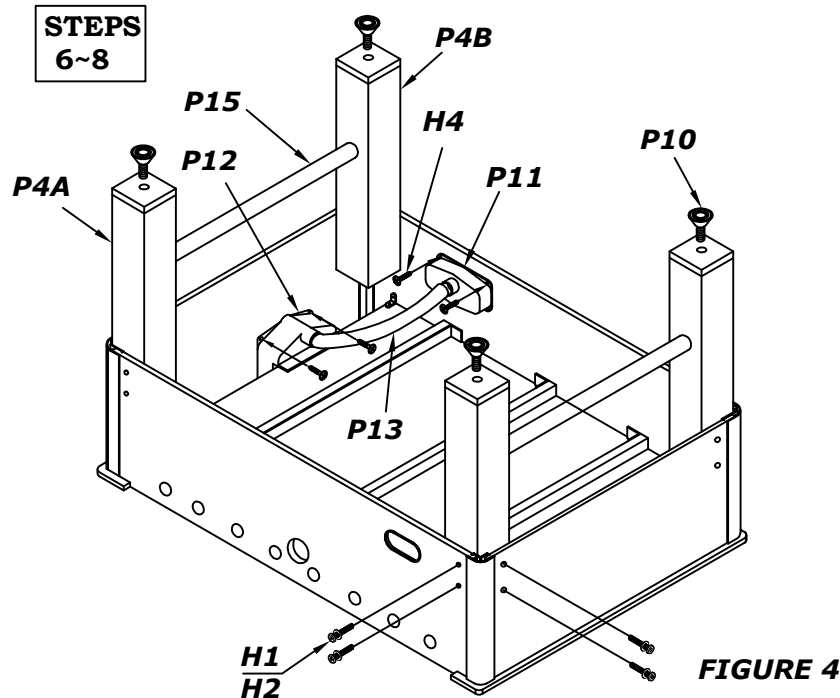
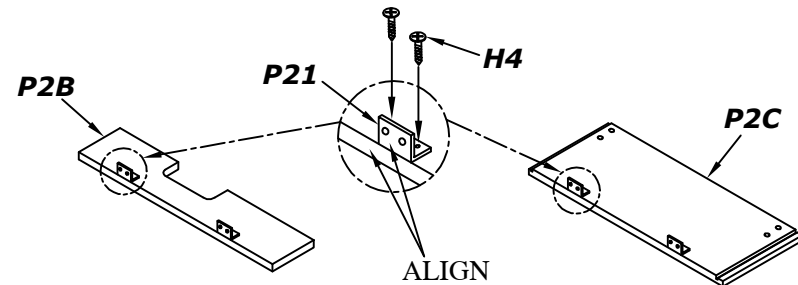

FIGURE 4

ASSEMBLY INSTRUCTIONS

SOCCKER TABLE ASSEMBLY

- 1 ATTACH THE END PANEL BRACKET **P21** TO THE INSIDE OF **P2B** AND **P2C**. PLACE SIDE PANELS **P1** UPSIDE DOWN WITH THE SLOT FACING INWARD AS SHOWN IN **figure 1**. (BALL ENTRY HOLE WILL BE CLOSEST TO THE FLOOR.)
- 2 ATTACH THE TWO END PANELS **P2B** TO THE SIDEPANEL **P1** WITH SCREW **H3** AS SHOWN IN **figure 1**.
- 3 ATTACH THE TWO END PANELS **P2A** TO THE SIDEPANEL **P1** WITH SCREW **H4** AS SHOWN IN **figure 1**



STEPS 1~3

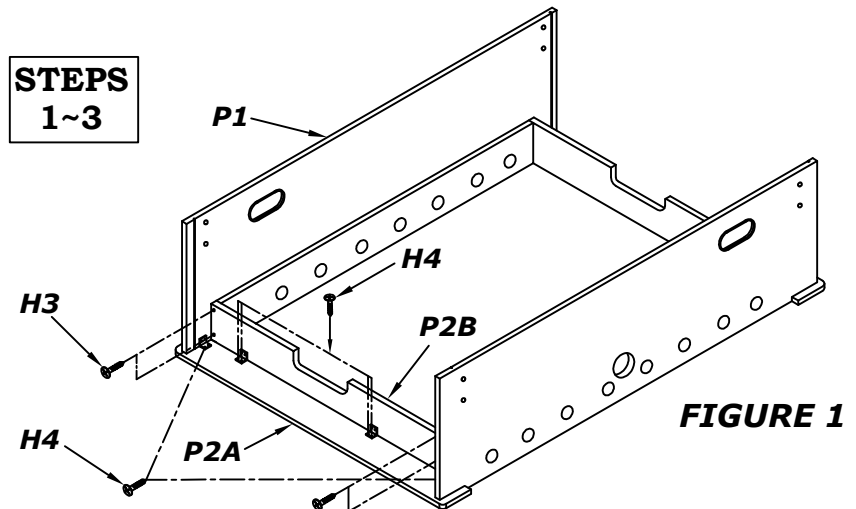

FIGURE 1

ASSEMBLY INSTRUCTIONS

SOCCKER TABLE ASSEMBLY

WARING: TWO ADULTS NEEDED TO ASSEMBLE SOCCER TABLE

- 4 SET THE PLAYFIELD **P3** ONTO THE ASSEMBLY AND ATTACH WITH SCREWS **H3** AS SHOWN IN **FIGURE 2**.
PLACE THE PLAYFIELD SUPORT BRACES ON THE BOTTOM OF THE PLAYFIELD. ATTATCH THE BRACES USING BRACKETS **P20** AND SCREWS **H4**. AS SHOWN IN **FIGURE 2**.
ATTACH THE BRACKET **P6** TO THE SIDE PANELS AND THE PLAYFIELD WITH SCREWS **H4** AS SHOWN IN **figure 2**.

STEP
4

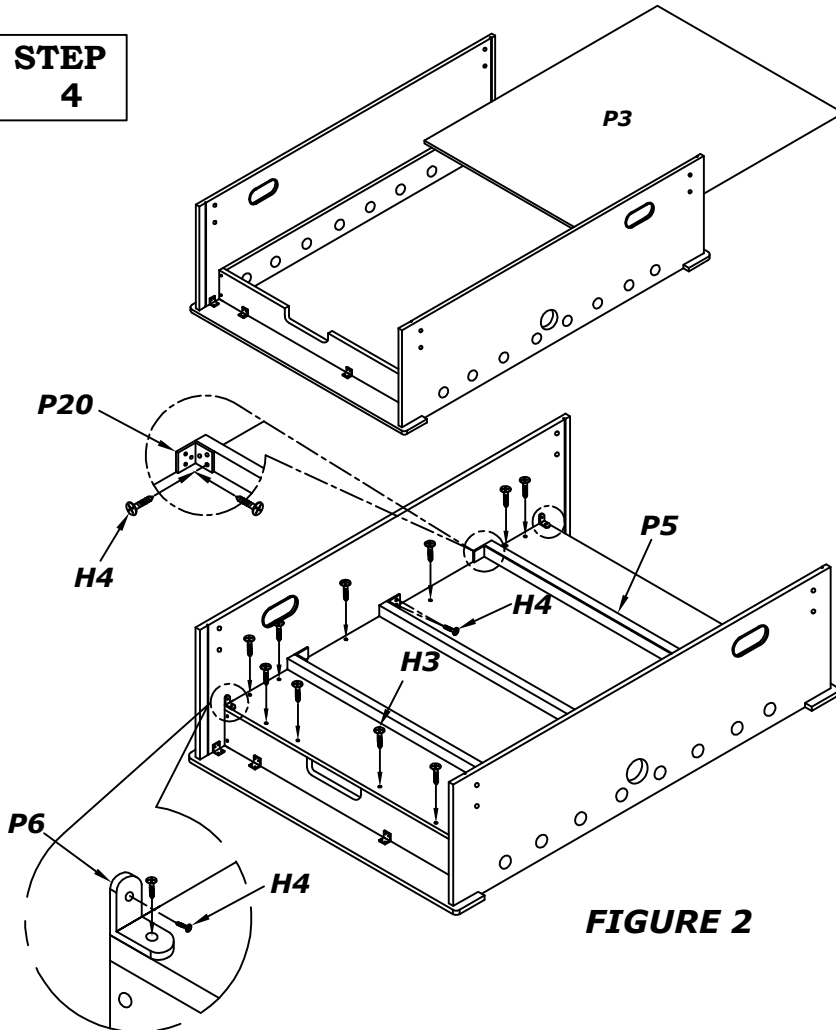

FIGURE 2

ASSEMBLY INSTRUCTIONS

SOCCKER TABLE ASSEMBLY

WARNING: TWO ADULTS NEEDED TO ASSEMBLE SOCCER TABLE

- 5 INSERT THE CORNER **P17** TO THE SIDE PANELS AND THE END PANEL **P2C**. FIXED IT WITH SCREWS **H4** AS SHOWN IN **figure 3**. ASSEMBLY THE END PANEL **P2C** WITH SCREW **H4** AS SHOWN IN **figure 3**

STEP
5

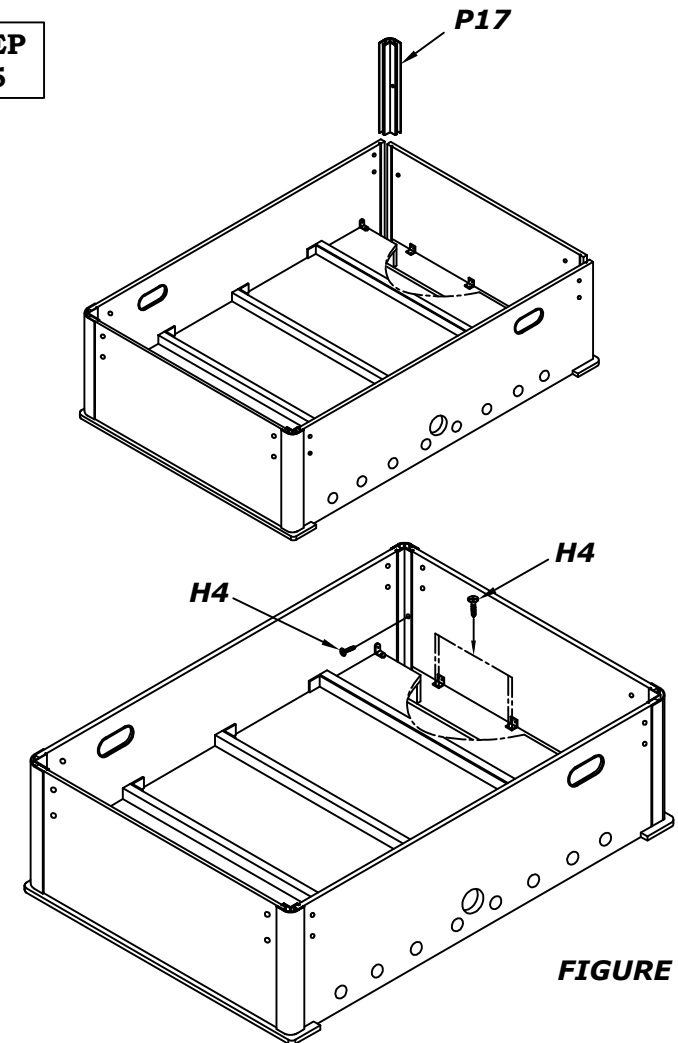

FIGURE 3