

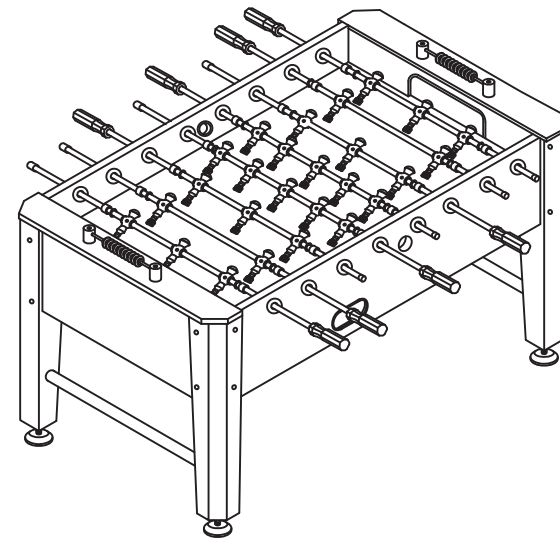

# TABLE SOCCER

ASSEMBLY INSTRUCTIONS



# ASSEMBLY INSTRUCTIONS

## SOCGER TABLE ASSEMBLY

**WARNING: TWO ADULTS NEEDED TO ASSEMBLE SOCCER TABLE**



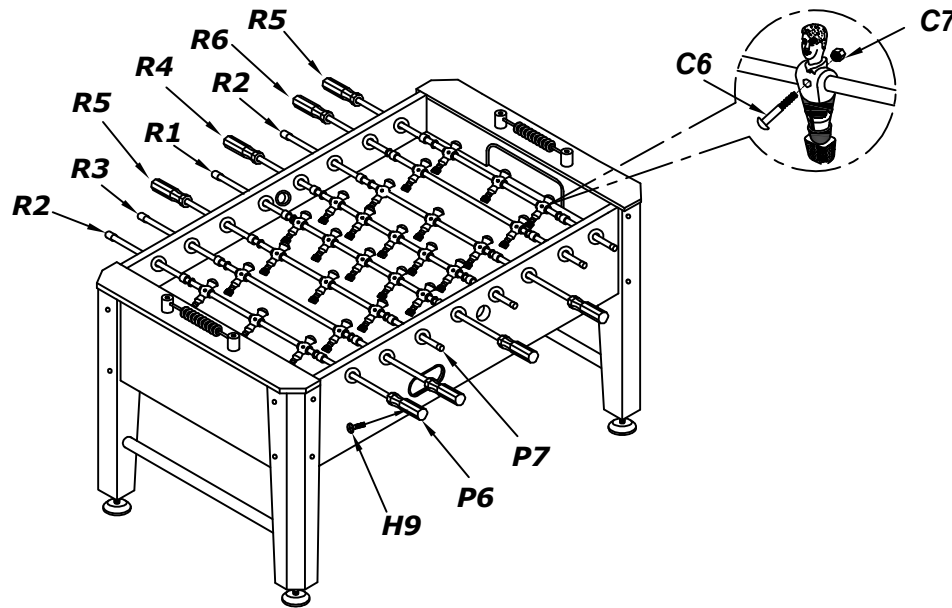



11. INSERT THE PLAYER ROD **R1~R6** INTO THE SIDE PANELS, ATTACH THE PLAYERS AND STOPRING WITH **C6&C7**.
12. SLIDE THE HANDLES **P6** ONTO THE ENDS OF THE RODS WITH THE HOLE CLOSE TO THE END. ATTACH THE HANDLES WITH **H9**. SLIDE THE RUBBER CAPS **P7** ON THE OTHER END OF THE ROD.



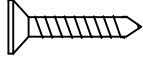
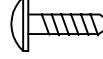
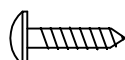
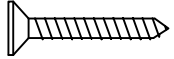

**FIGURE 6**

# PARTS IDENTIFIER

## HARDWARE











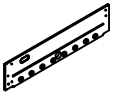
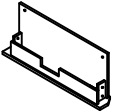



	DESCRIPTION	QTY. REQUIRED <small>(EXTRA PIECES MAY BE INCLUDED)</small>
	<b>H1</b> 5/16"x1-1/4" BOLT	16
	<b>H2</b> 5/16" WASHER,	16
	<b>H3</b> 1/4"x1-3/4" BOLT	8
	<b>H4</b> 1/4" WASHER,	8
	<b>H5</b> 1-1/8"FLAT HEAD PHILLIPS SCREW	8
	<b>H6</b> 1/2"ROUND HEAD PHILLIPS SCREW	48
	<b>H7</b> 5/8"ROUND HEAD PHILLIPS SCREW	6
	<b>H8</b> 1-3/4"FLAT HEAD PHILLIPS SCREW	4
	<b>H9</b> BOLT (used to install handle)	8
	<b>S1</b> 1/2"FLAT HEAD PHILLIPS SCREW	24

## ACCESSORIES

		QTY
	<b>A1</b> SOCCER BALL	4
	<b>A2</b> TOOL	1

# PARTS IDENTIFIER

## ASSEMBLY PARTS

	DESCRIPTION	QTY
	<b>P1</b> SIDE PANEL	2
	<b>P2</b> END PANEL	2
	<b>P3</b> PLAYING FIELD	1
	<b>P4A</b> LEG A	2
	<b>P4B</b> LEG B	2
	<b>P5</b> PLAYFIELD SUPPORT BRACE	3
	<b>P6</b> HANDLE	8
	<b>P7</b> ROD END CAP	8
	<b>P8</b> SUPPORT BRACKET	6
	<b>P9</b> BALL ENTRY CUP	2
	<b>P10</b> LEG LEVELER	4
	<b>P11</b> SLIDE SCORER	2
	<b>P12</b> BALL CATCHER	2
	<b>P13</b> GOAL	2
	<b>P14</b> BALL RUNNER	2
	<b>P15</b> CROSS BAR	2

# ASSEMBLY INSTRUCTIONS

## SOCCER TABLE ASSEMBLY

**WARNING: TWO ADULTS NEEDED TO ASSEMBLE SOCCER TABLE**

- ATTACH THE TWO SETS OF SLIDE SCORER **P11** TO THE END OF TABLE WITH SCREWS **H8**.  
ATTACH BALL ENTRY CUP **P9** WITH SCREWS **H7**.
- ATTACH THE PLASTIC **#2a, #2b, #3a, #3b**, TO THE PLAYING FIELD WITH **S1** AS SHOWN IN **Figure 5**.

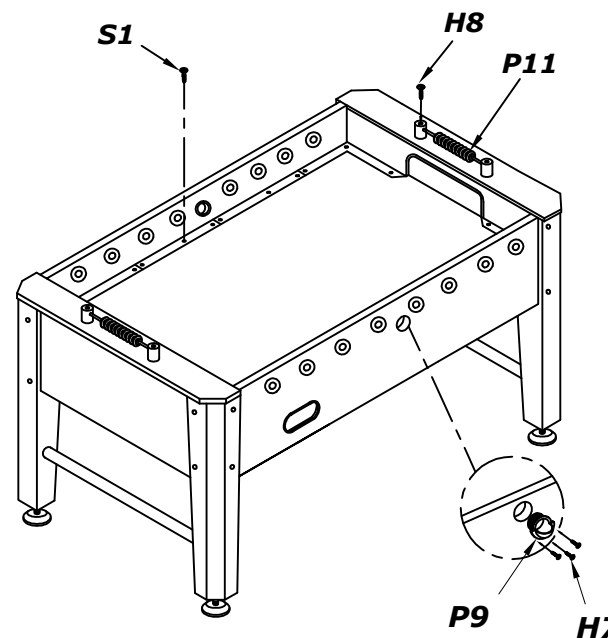

**FIGURE 5**

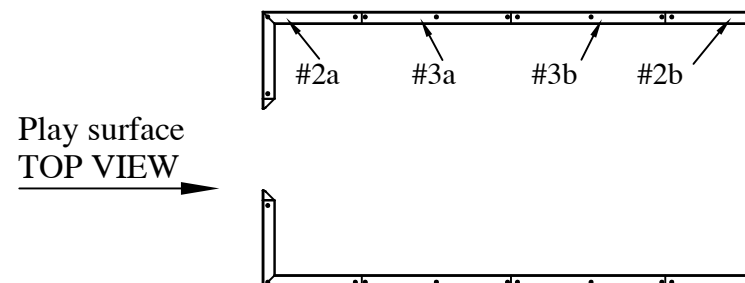

# ASSEMBLY INSTRUCTIONS

## SOCGER TABLE ASSEMBLY

**WARNING: TWO ADULTS NEEDED TO ASSEMBLE SOCCER TABLE**

6. INSERT CROSS BAR **P15** INTO LEGS AS SHOWN IN **FIGURE 4**. ATTACH THE LEGS **P4A&P4B** AS SHOWN IN **figure 4**. THE LEGS ARE ATTACHED WITH BOLTS **H1** AND WASHERS **H2**. \*TIGHTEN HARDWARE AT THIS TIME!
7. ATTACH THE LEG LEVELERS **P10** AS SHOWN IN **figure 4**.
8. PLACE THE GOAL **P13** OVER THE HOLE IN THE END PANEL AND ATTACH USING SCREWS **H6**. PLACE THE BALL CATCHER **P12** OVER THE HOLE IN THE SIDE PANEL AND ATTACH USING SCREWS **H6**. SECURE THE BALL RUNNER **P14** BETWEEN EACH GOAL AND BALL CATCHER. SEE **figure 4**. (REPEAT ABOVE STEP FOR OTHER END OF TABLE)

### WARNING



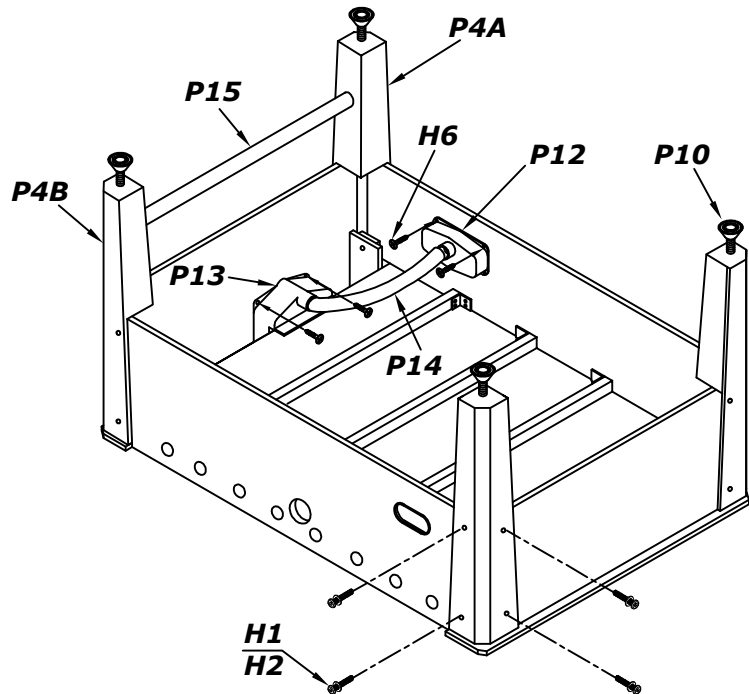





This step requires two adults!  
Very carefully turn the table over and set on its legs. Be careful!

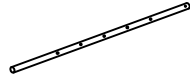

**FIGURE 4**

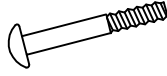
# PARTS IDENTIFIER

## REPLACEMENT PARTS

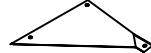
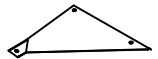
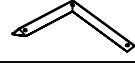
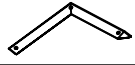
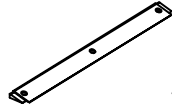
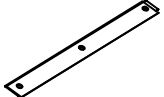
	DESCRIPTION	QTY
 <b>C1</b>	5 PLAYER ROD	2
 <b>C2</b>	3 PLAYER ROD	4
 <b>C3</b>	2 PLAYER ROD	2
 <b>C4</b>	RUBBER BUSHING	16
 <b>C5</b>	PLASTIC ROD WASHERS	16
 <b>C6</b>	BOLT(used to install men)	26
 <b>C7</b>	LOCKING NUT (used to install men)	26
 <b>C8</b>	HOME MEN	13
 <b>C9</b>	AWAY MEN	13
 <b>#1a</b>	TRIANGLE a	2
 <b>#1b</b>	TRIANGLE b	2
 <b>#2a</b>	L STYLE PLASTIC a	2
 <b>#2b</b>	L STYLE PLASTIC b	2
 <b>#3a</b>	LONG PLASTIC a	2
 <b>#3b</b>	LONG PLASTIC b	2

# ASSEMBLY INSTRUCTIONS

## SOCCKER TABLE ASSEMBLY

1. PLACE SIDE PANELS **P1** UPSIDE DOWN WITH THE SLOT FACING AS SHOWN IN **figure 1** . (BALL ENTRY HOLE WILL BE CLOSEST TO THE FLOOR. )
2. INSERT PLAY FIELD **P3** INTO THE GROOVE ON THE SIDE PANELS **P1** WITH GRAPHICS FACING DOWN. SEE **figure 1** .

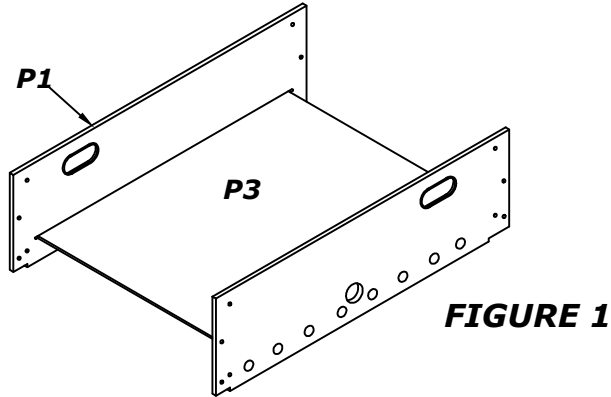

**FIGURE 1**

3. ATTACH THE TWO END PANELS **P2** TO THE SIDEPANEL **P1** WITH **H3,H4** AS SHOWN IN **figure 2** .
4. ATTACH THE PLAYFIELD **P3** WITH SCREWS **H5** AS SHOWN IN **FIGURE 2** .

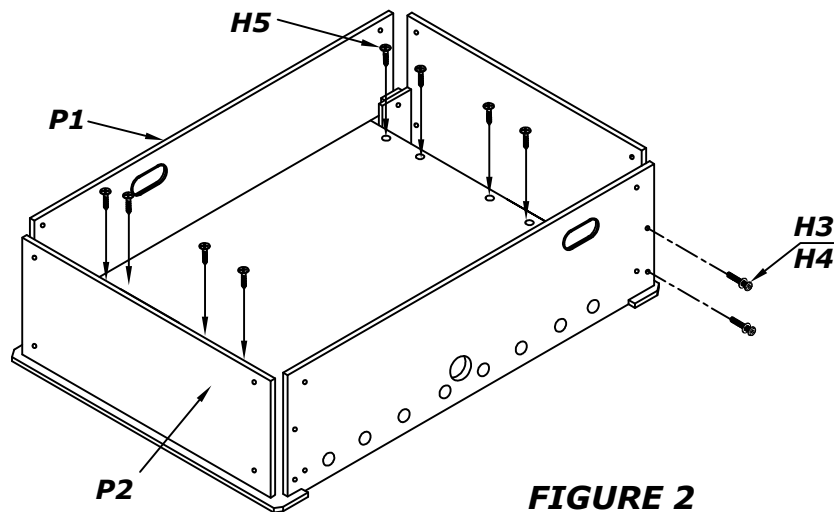

**FIGURE 2**

# ASSEMBLY INSTRUCTIONS

## SOCCKER TABLE ASSEMBLY

**WARNING: TWO ADULTS NEEDED TO ASSEMBLE SOCCER TABLE**

5. PLACE THE PLAYFIELD SUPPORT BRACES **P5** ON THE BOTTOM OF THE PLAYFIELD. ATTATCH THE BRACES USING BRACKETS **P8** AND SCREWS **H6**. AS SHOWN IN **FIGURE 3** .

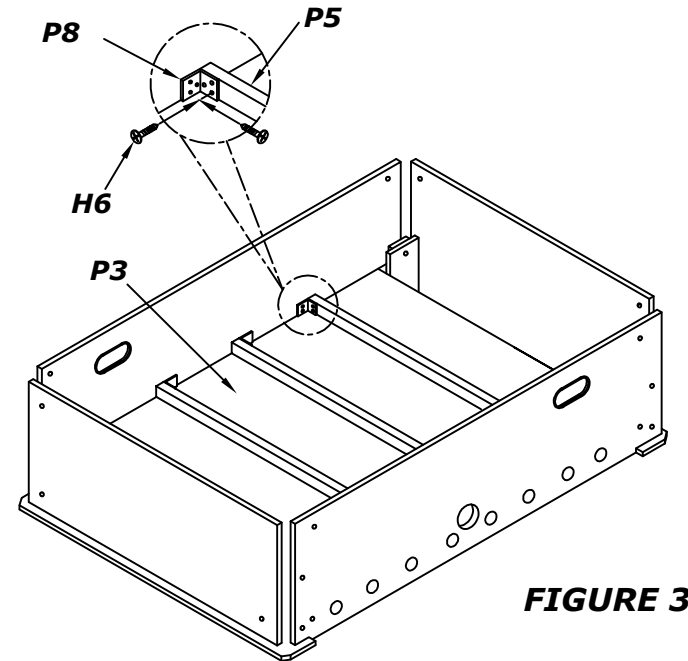
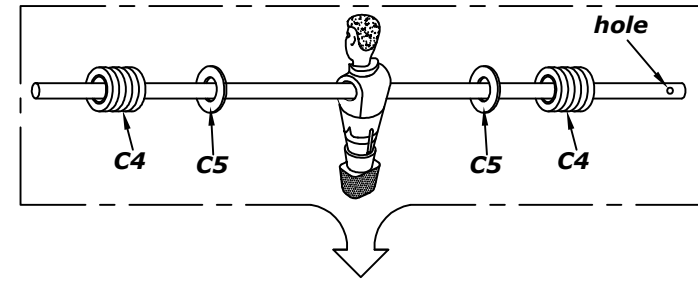



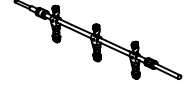

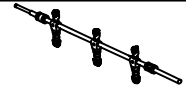

**FIGURE 3**

# ASSEMBLY INSTRUCTIONS

## SOCCKER TABLE ASSEMBLY

WARNING: TWO ADULTS NEEDED TO ASSEMBLE SOCCER TABLE



	<b>R1</b>	5 HOME PLAYERS ROD	1
	<b>R2</b>	3 HOME PLAYERS ROD	2
	<b>R3</b>	2 HOME PLAYERS ROD	1
	<b>R4</b>	5 AWAY PLAYERS ROD	1
	<b>R5</b>	3 AWAY PLAYERS ROD	2
	<b>R6</b>	2 AWAY PLAYERS ROD	1