

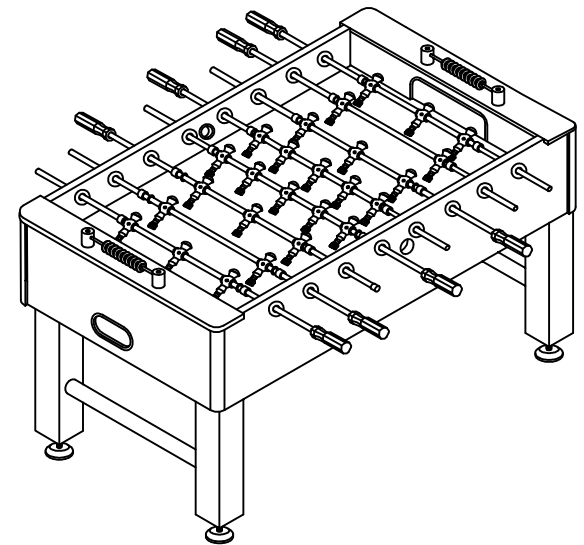







# TABLE SOCCER

ASSEMBLY INSTRUCTIONS

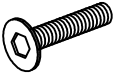

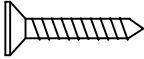
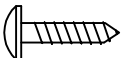
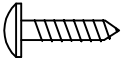

# PARTS IDENTIFIER

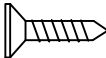
## HARDWARE

	DESCRIPTION	QTY. REQUIRED
	<b>H1</b> 5/16"x1-1/4" BOLT	16
	<b>H2</b> 5/16" WASHER,	16
	<b>H3</b> 1/4"x2-5/8" BOLT	8
	<b>H4</b> 1/4" WASHER,	8
	<b>H5</b> 1-1/8"FLAT HEAD PHILLIPS SCREW	8
	<b>H6</b> 1/2"ROUND HEAD PHILLIPS SCREW	40
	<b>H7</b> 5/8"ROUND HEAD PHILLIPS SCREW	6
	<b>H8</b> 1-3/4"FLAT HEAD PHILLIPS SCREW	4
	<b>H9</b> SCREW (used to install handle)	8
	<b>S1</b> 5/8"FLAT HEAD PHILLIPS SCREW	24

## ACCESSORIES

QTY







	<b>A1</b> SOCCER BALL	4
	<b>A2</b> TOOL	1

# ASSEMBLY INSTRUCTIONS

## SOCCKER TABLE ASSEMBLY











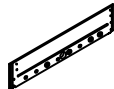





WARNING: TWO ADULTS NEEDED TO ASSEMBLE SOCCER TABLE

REFERENCE PICTURE OF PLAYER ROD AFTER ASSEMBLY

		QTY
	<b>R1</b> 5 HOME PLAYERS ROD	1
	<b>R2</b> 3 HOME PLAYERS ROD	2
	<b>R3</b> 2 HOME PLAYERS ROD	1
	<b>R5</b> 5 AWAY PLAYERS ROD	1
	<b>R6</b> 3 AWAY PLAYERS ROD	2
	<b>R7</b> 2 AWAY PLAYERS ROD	1

# PARTS IDENTIFIER

## ASSEMBLY PARTS

	DESCRIPTION	QTY
	<b>P1</b> SIDE PANEL	2
	<b>P2</b> END PANEL	2
	<b>P3</b> PLAYING FIELD	1
	<b>P4A</b> LEG A	2
	<b>P4B</b> LEG B	2
	<b>P5</b> PLAYFIELD SUPPORT BRACE	3
	<b>P6</b> SUPPORT BRACKET	6
	<b>P7</b> HANDLE	8
	<b>P8</b> BALL ENTRY CUP	2
	<b>P9</b> LEG LEVELER	4
	<b>P10</b> ROD END CAP	8
	<b>P11</b> SLIDE SCORER	2
	<b>P12</b> CROSS BAR	2
	<b>P13</b> CORNER	4
	<b>#1a</b> TRIANGLE a	2
	<b>#1b</b> TRIANGLE b	2
	<b>#2a</b> L STYLE PLASTIC a	2
	<b>#2b</b> L STYLE PLASTIC b	2





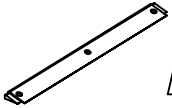
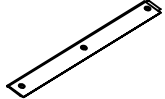

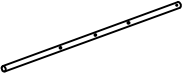

# ASSEMBLY INSTRUCTIONS

## SOCCKER TABLE ASSEMBLY

	#3a	LONG PLASTIC a	2
	#3b	LONG PLASTIC b	2

## PARTS IDENTIFIER

### REPLACEMENT PARTS

	DESCRIPTION	QTY
	C1 5 PLAYER ROD	2
	C2 3 PLAYER ROD	4
	C3 2 PLAYER ROD	2
	C4 RUBBER BUSHING	16
	C5 PLASTIC ROD WASHERS	16
	C6 BOLT(used to install men)	26
	C7 LOCKING NUT (used to install men)	26
	C8 HOME MEN	13
	C9 AWAY MEN	13

- AS SHOWN IN **FIGURE 6**, INSERT THE PLAYERS ROD **R1~ R7**, WASHER **C5**, RUBBER **C4** THROUGH THE HOLE OF THE TWO SIDE PANELS FROM THE INSIDE TO THE OUTSIDE IN POWER.
- SLIDE THE HANDLES **P7** ONTO THE ENDS OF THE RODS WITH BOLT **H9**. SLIDE THE RUBBER CAPS **P10** ON THE OTHER END OF THE ROD .

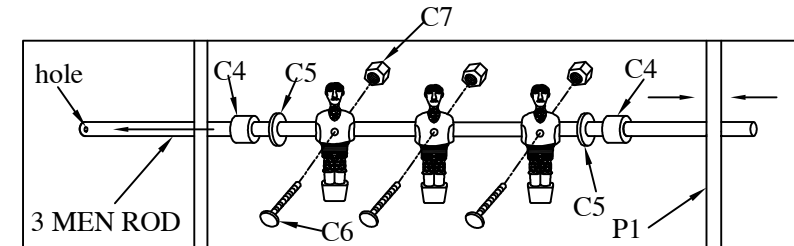

### STEPS

#### 10.11

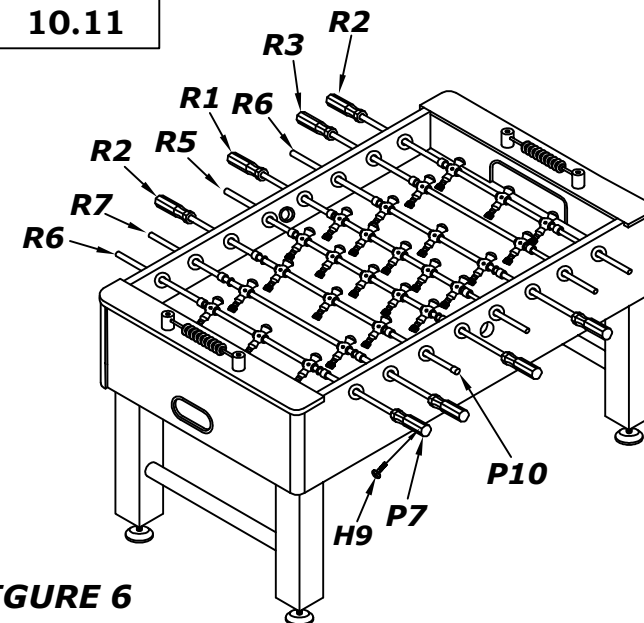

**FIGURE 6**

# ASSEMBLY INSTRUCTIONS

## SOCCKER TABLE ASSEMBLY

8. ATTACH BALL ENTRY CUPS **P8** TO THE SIDE PANELS WITH **H7** AS SHOWN IN **figure 5**.  
ATTACH THE TWO SETS OF SLIDE SCORER **P11** TO THE END OF TABLE WITH SCREWS **H8**.
9. ATTACH THE PLASTIC **#2a, #2b, #3a, #3b**, TO THE PLAYING FIELD WITH **S1** AS SHOWN IN **Figure 5**.

**STEPS**  
**8.9**

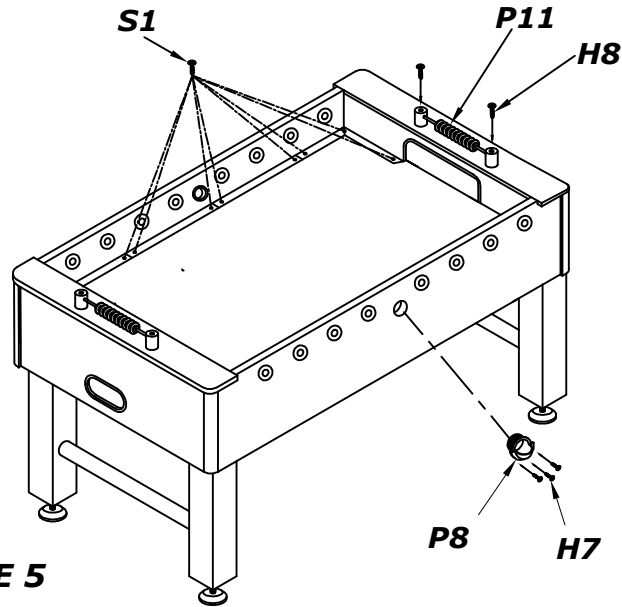

**FIGURE 5**

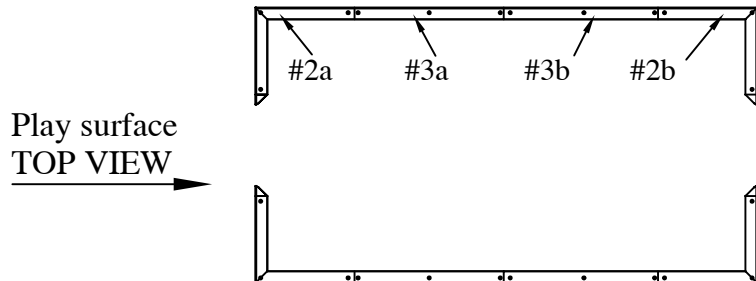

# ASSEMBLY INSTRUCTIONS

## SOCCKER TABLE ASSEMBLY

**IMPORTANT:**

Please read through the instruction book before attempting assembly to familiarize yourself with all part and assembly steps

1. CUT CORNERS OF THE BOX AND PLACE IT ON THE FLOOR TO PROTECT THE PARTS AS THE UNIT IS BEING ASSEMBLED. PLACE SIDE PANELS **P1** UPSIDE DOWN AS SHOWN IN **figure 1** . (THE ROUND BALL ENTRY HOLE WILL BE CLOSEST TO THE FLOOR.)
2. INSERT PLAYFIELD **P3** INTO THE GROOVE ON THE SIDE PANELS **P1** WITH GRAPHICS FACING DOWN. SEE **FIGURE 1**.

**STEPS**  
**1.2**

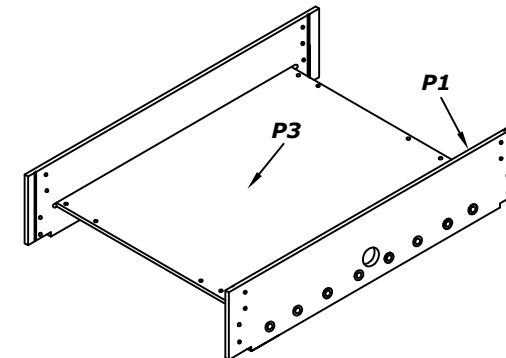

**FIGURE 1**

# ASSEMBLY INSTRUCTIONS

## SOCCKER TABLE ASSEMBLY

WARNING: TWO ADULTS NEEDED TO ASSEMBLE SOCCER TABLE

3. INSERT THE CORNER TO THE SIDE AND END PANLES.  
ATTACH THE TWO END PANELS **P2** TO THE SIDE PANELS **P1** WITH BOLTS **H3** AND WASHERS **H4** AS SHOWN IN **FIGURE 2**.
4. ATTACH THE CORNER IN THE ENDS AS WITH SCREW **H6** SHOWN IN **figure 2**.

STEPS  
3.4

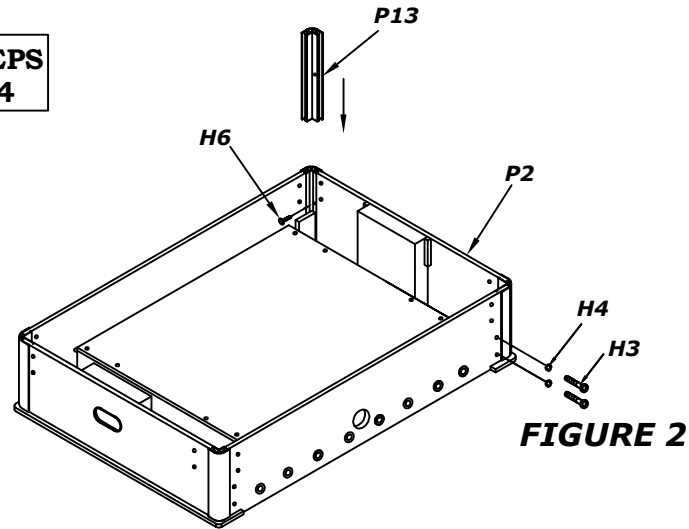

5. ATTACH PLAY FIELD WITH SCREWS **H5** AS SHOWN IN **figure 3**.

STEPS  
5

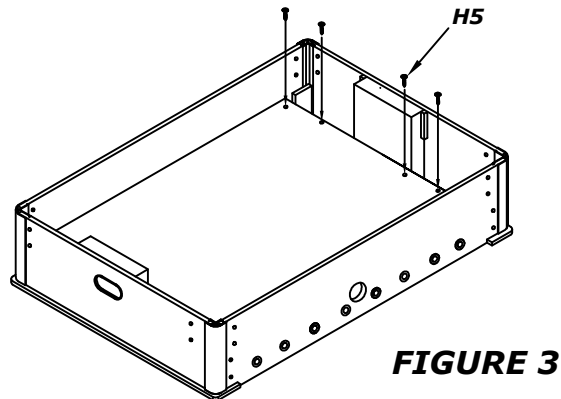

# ASSEMBLY INSTRUCTIONS

## SOCCKER TABLE ASSEMBLY

WARNING: TWO ADULTS NEEDED TO ASSEMBLE SOCCER TABLE

6. PLACE THE PLAYFIELD SUPORT BRACES ON THE BOTTOM OF THE PLAYFIELD. ATTATCH THE BRACES USING BRACKETS **P6** AND SCREWS **H6**.  
INSERT CROSS BAR **P12** INTO LEGS AS SHOWN IN **FIGURE 4**.  
ATTACH THE LEGS **P4&P4B** AS SHOWN IN **figure 4**.  
THE LEGS ARE ATTACHED WITH BOLTS **H1** AND WASHERS **H2**.
7. ATTACH THE LEG LEVELERS **P9** AS SHOWN IN **figure 4**.

### WARNING

This step requires two adults!

Very carefully turn the table over and set on its legs. Be careful!  
The table is very heavy and the rods will slide.

STEPS  
6.7

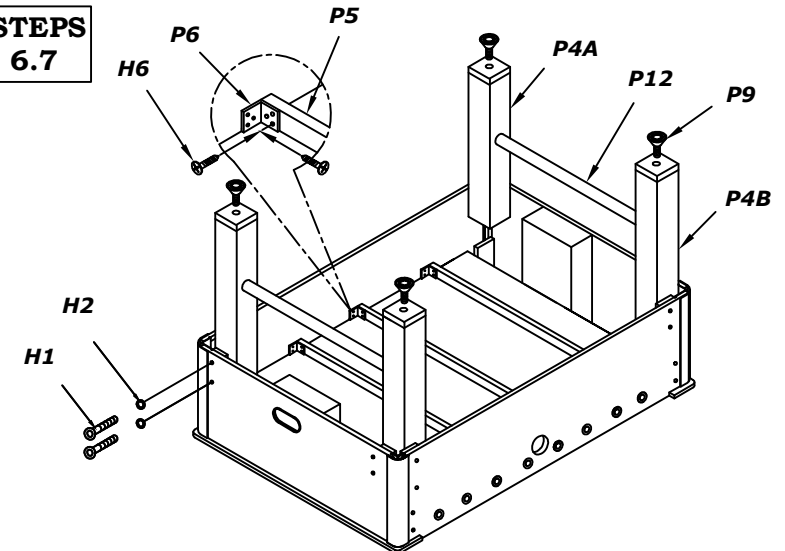

**FIGURE 4**