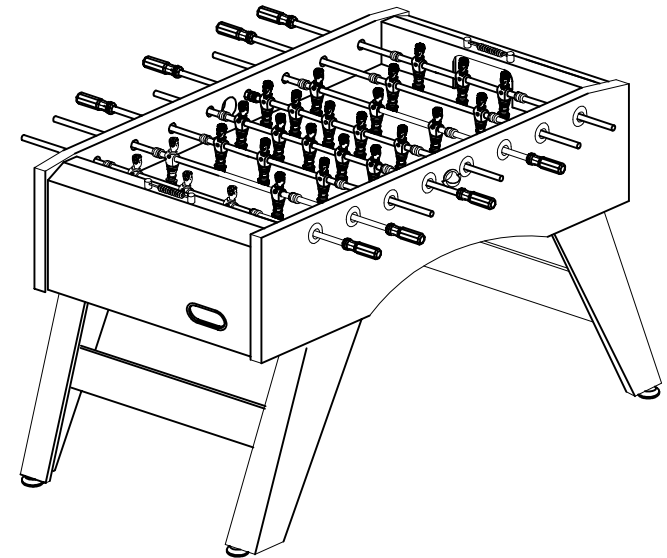



TABLE SOCCER

ASSEMBLY INSTRUCTIONS



ASSEMBLY INSTRUCTIONS

SOCCER TABLE ASSEMBLY

WARNING: TWO ADULTS NEEDED TO ASSEMBLE SOCCER TABLE

7. INSERT THE PLAYER RODS **C1&C2&C3** THROUGH ONE SIDE PANEL, THEN INSERT PLAYERS **C8&C9** AND RUBBER BUSHINGS **C4**, PLASTIC WASHERS **C5** THROUGH THE ROD, REFER TO **R1~R6**. THEN INSERT THE PLAYER ROD THROUGH OTHER SIDE PANEL, ATTACH THE PLAYERS **C8&C9** WITH BOLTS **C6** AND NUTS **C7**. SEE **Figure 6**.
8. ATTACH THE HANDLES **P7** WITH BOLT **H12**. SLIDE THE RUBBER CAPS **P8** ON THE OTHER END OF THE ROD.

Tighten all the hardware before playing games !

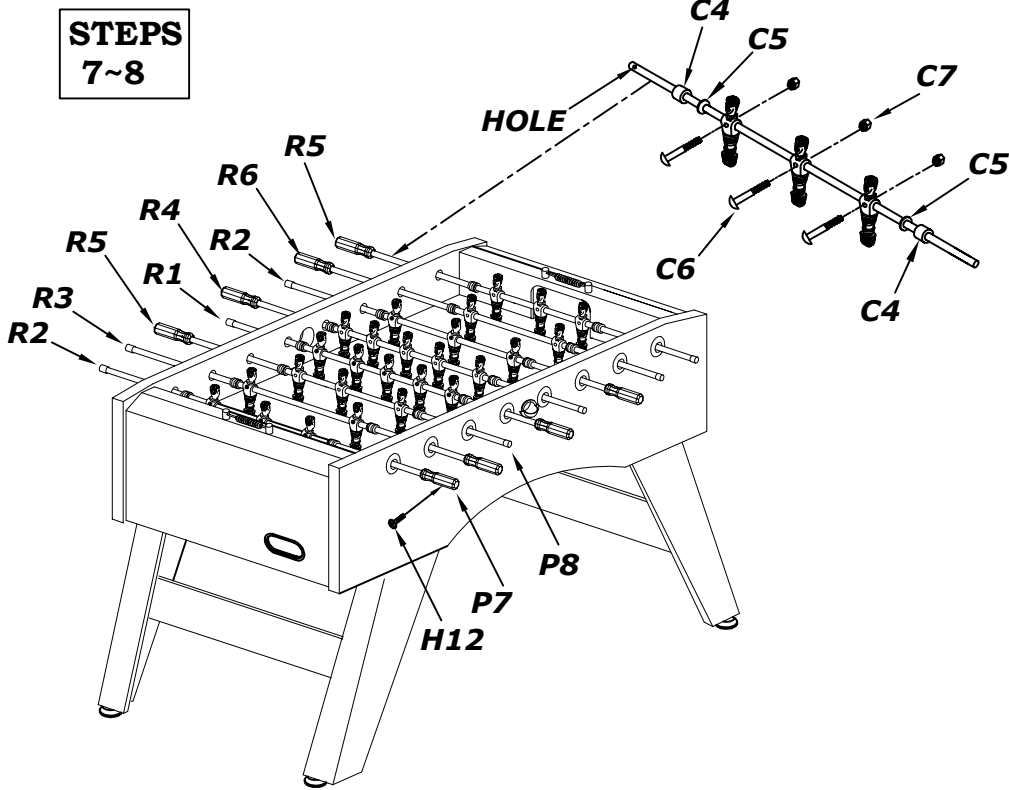
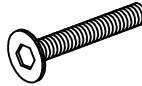







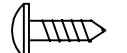







FIGURE 6

PARTS IDENTIFIER

HARDWARE











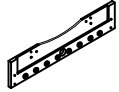





	DESCRIPTION	QTY. REQUIRED <small>(EXTRA PIECES MAY BE INCLUDED)</small>
	H1 5/16"x1-3/4" BOLT	12
	H2 5/16" WASHER	24
	H3 5/16" LOCK HEX NUT	12
	H4 1/4"x1-1/2" BOLT	8
	H5 1/4"x2" BOLT	8
	H6 1/4" WASHER	24
	H7 1/4" LOCK HEX NUT	8
	H8 1-1/8" FLAT HEAD PHILLIPS SCREW	16
	H9 1/2" ROUND HEAD PHILLIPS SCREW	36
	H10 5/8" ROUND HEAD PHILLIPS SCREW	2
	H11 1-3/4" FLAT HEAD PHILLIPS SCREW	4
	H12 SCREW (used to install handle)	8
	S1 5/8" FLAT HEAD PHILLIPS SCREW	24

ACCESSORIES

		QTY
	A1 SOCCER BALL	6
	A2 TOOL	2

PARTS IDENTIFIER

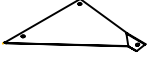
ASSEMBLY PARTS

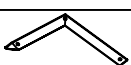
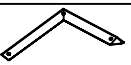
	DESCRIPTION	QTY
	P1 SIDE PANEL	2
	P2 END PANEL	2
	P3 PLAYING FIELD	1
	P4A LEG A	2
	P4B LEG B	2
	P4C LEG PANEL	2
	P5 PLAYFIELD SUPPORT BRACE	3
	P6 SUPPORT BRACKET	6
	P7 HANDLE	8
	P8 ROD END CAP	8
	P9A BALL ENTRY CUP	2
	P9B BALL ENTRY SOCKET	2
	P10 SLIDE SCORER	2
	P11 LEG LEVELER	4
	#1a TRIANGLE a	2
	#1b TRIANGLE b	2
	#2a L STYLE PLASTIC a	2
	#2b L STYLE PLASTIC b	2

ASSEMBLY INSTRUCTIONS

SOCCER TABLE ASSEMBLY

WARNING: TWO ADULTS NEEDED TO ASSEMBLE SOCCER TABLE

- ATTACH BALL ENTRY CUPS **P9A** AND **P9B** TO THE SIDE PANELS WITH SCREWS **H10** AS SHOWN IN **figure 5**. ATTACH THE TWO SETS OF SLIDE SCORER **P10** TO THE END OF TABLE WITH PHILLIS HEAD SCREWS **H11**.
- ATTACH THE PLASTIC **#2a, #2b, #3a, #3b**, TO THE PLAYING FIELD WITH **S1** AS SHOWN IN **Figure 5**.

STEPS
5.6

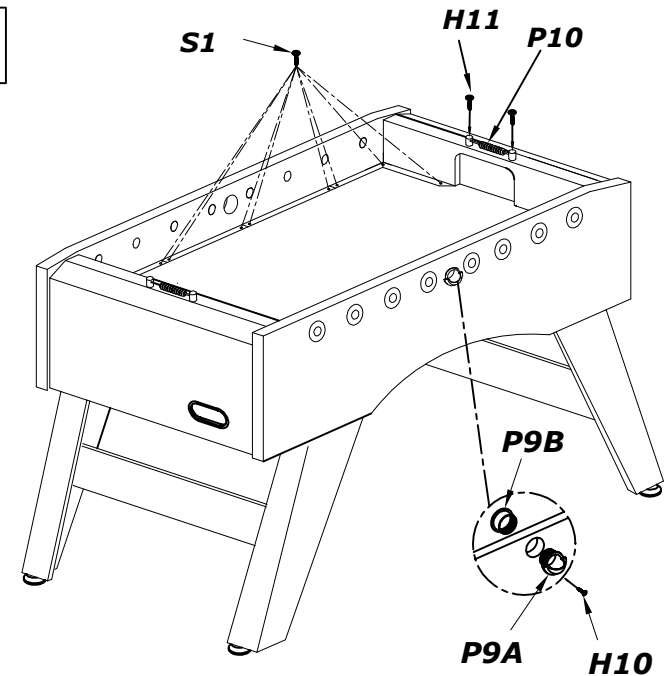
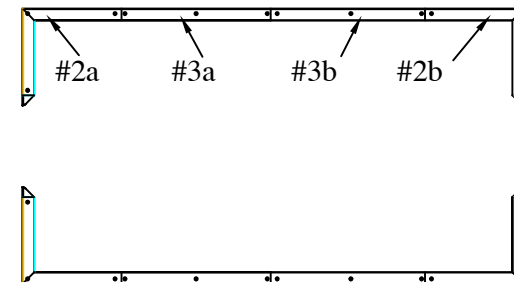

FIGURE 5

Play surface
TOP VIEW



ASSEMBLY INSTRUCTIONS

SOCCER TABLE ASSEMBLY

WARNING: TWO ADULTS NEEDED TO ASSEMBLE SOCCER TABLE

4. ATTACH THE LEGS **P4A&P4B** AS SHOWN IN **figure 4** .
 THE LEGS ARE ATTACHED WITH BOLTS **H1**, AND WASHERS **H2**. NUT **H3**
 ATTACH THE LEG PANEL **P4C** WITH BOLT **H4**, WASHER **H6**, NTU **H7**.
 TIGHTEN HARDWARE AT THIS TIME.
 ATTACH THE LEG LEVELERS **P11** AS SHOWN IN **figure 4**.

WARNING

This step requires two adults!

Very carefully turn the table over.
 Be careful! The table is very heavy

STEP
4

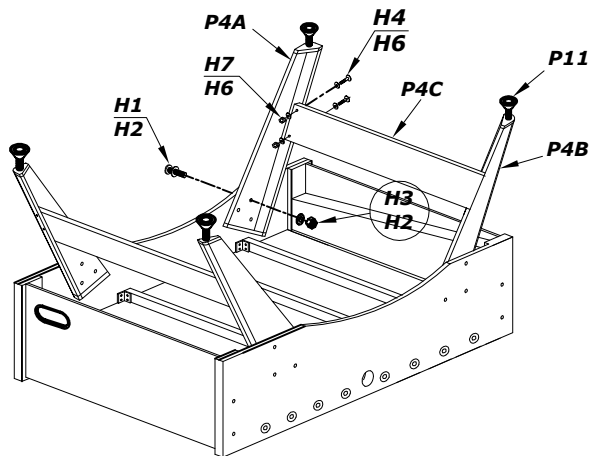
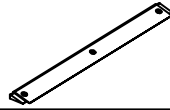
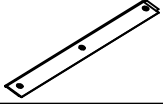
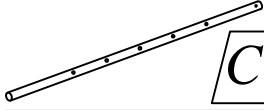
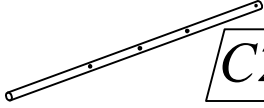
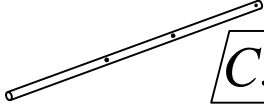

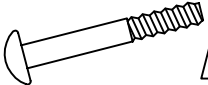





FIGURE 4

	#3a	LONG PLASTIC a	2
	#3b	LONG PLASTIC b	2

PARTS IDENTIFIER

REPLACEMENT PARTS

	DESCRIPTION	QTY	
	C1	5 PLAYER ROD	2
	C2	3 PLAYER ROD	4
	C3	2 PLAYER ROD	2
	C4	RUBBER BUSHING	16
	C5	PLASTIC ROD WASHERS	16
	C6	1-1/8" BOLT (used to install men)	26
	C7	LOCKING NUT (used to install men)	26
	C8	HOME MEN	13
	C9	AWAY MEN	13

ASSEMBLY INSTRUCTIONS

SOCCKER TABLE ASSEMBLY

WARNING: TWO ADULTS NEEDED TO ASSEMBLE SOCCER TABLE

1. ATTACH THE TWO END PANELS **P2** TO THE SIDE PANELS **P1** AS SHOWN IN **figure 1**. ATTACH THE END PANELS WITH BOLTS **H5** AND WASHERS **H6**.

STEP
1

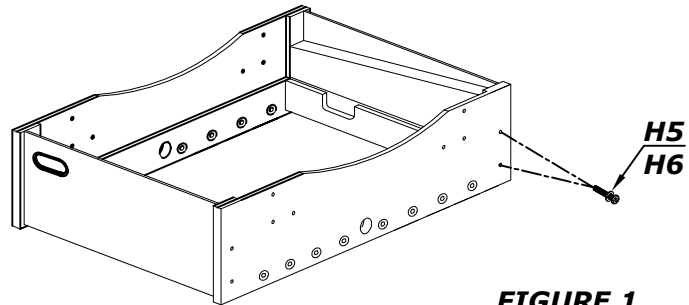

FIGURE 1

2. ATTACH PLAY FIELD WITH SCREWS **H8** IN THE END AND SIDE PANEL AS SHOWN IN **figure 2**.

STEP
2

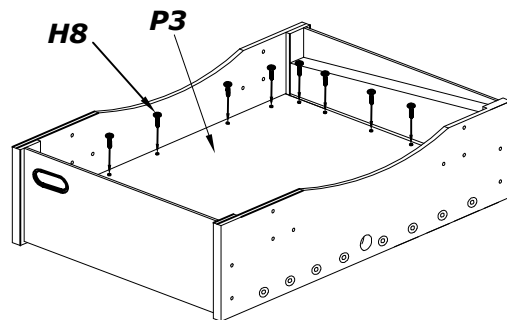

FIGURE 2

ASSEMBLY INSTRUCTIONS

SOCCKER TABLE ASSEMBLY

WARNING: TWO ADULTS NEEDED TO ASSEMBLE SOCCER TABLE

3. PLACE THE PLAYFIELD SUPPORT BRACES **P5** ON THE BOTTOM OF THE PLAYFIELD. ATTATCH THE BRACES USING BRACKETS **P6** AND SCREWS **H9**.AS SHOWN IN **figure 3**.

STEP
3

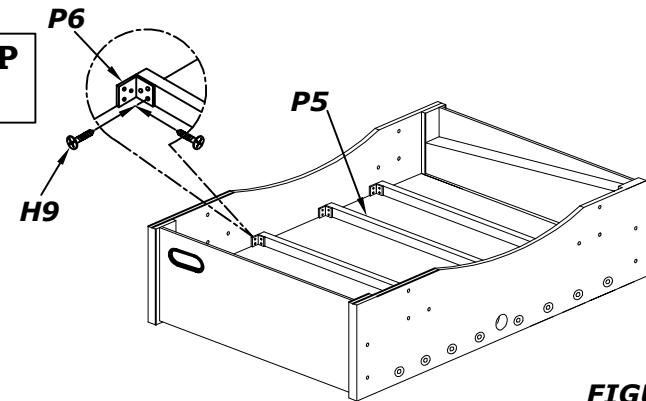
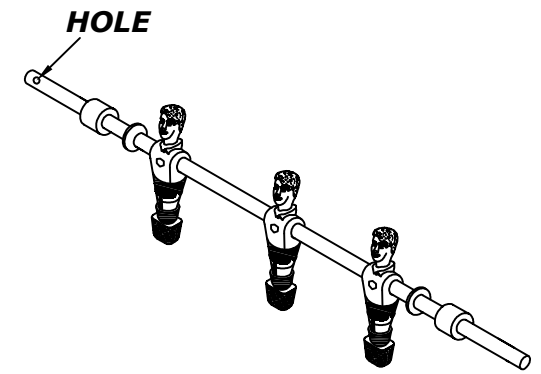

FIGURE 3

ASSEMBLY INSTRUCTIONS

SOCCER TABLE ASSEMBLY

WARNING: TWO ADULTS NEEDED TO ASSEMBLE SOCCER TABLE

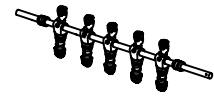
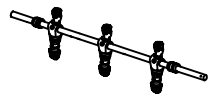
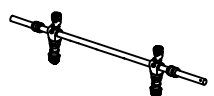
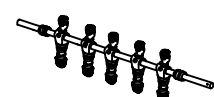
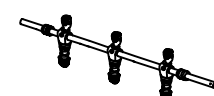
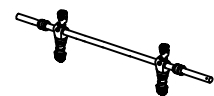

			<i>QTY</i>
	R1	5 HOME PLAYERS ROD	1
	R2	3 HOME PLAYERS ROD	2
	R3	2 HOME PLAYERS ROD	1
	R4	5 AWAY PLAYERS ROD	1
	R5	3 AWAY PLAYERS ROD	2
	R6	2 AWAY PLAYERS ROD	1