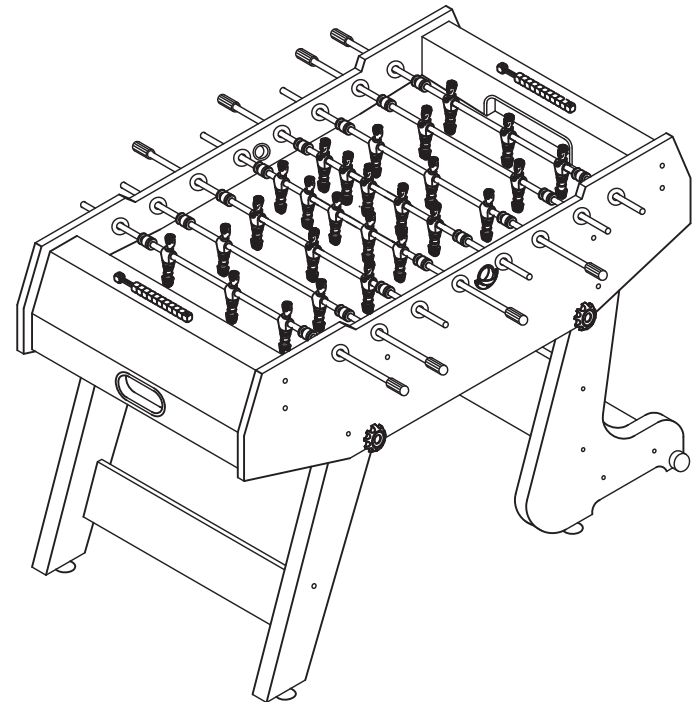
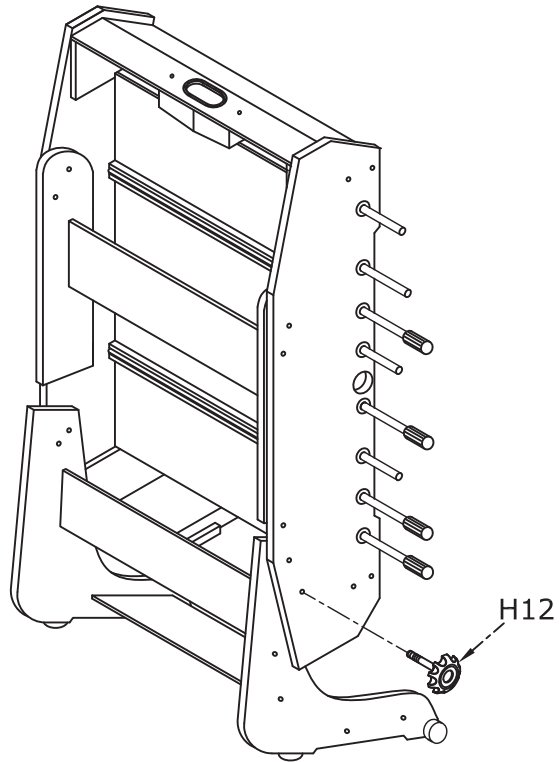



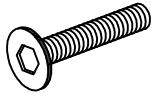
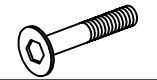



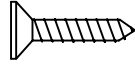
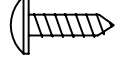
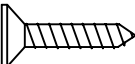



TABLE SOCCER

ASSEMBLY INSTRUCTIONS



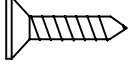

PARTS IDENTIFIER

HARDWARE

		DESCRIPTION	QTY.
	H1	5/16"x2-1/2" BOLT	4
	H2	1/4"x2" BOLT	20
	H3	1/4"x1/2" NUT	6
	H4	3/8" WASHER	6
	H5	5/16" WASHER	8
	H6	1/4" WASHER	20
	H7	1-1/8" FLAT HEAD SCREW	16
	H8	5/8" ROUND HEAD SCREW	8
	H9	1-1/2" FLAT HEAD SCREW	4
	H10	Screw (used to install handle)	8
	H11	CYLINDRICAL NUT	12
	H12	5/16" HANDLE NUT	4
	S1	5/8" FLAT HEAD SCREW	24

PARTS IDENTIFIER

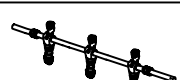
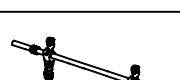
ASSEMBLY PARTS

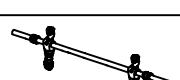
		DESCRIPTION	QTY.
	R1	5 Home Players Rod	1
	R2	3 Home Players Rod	2
	R3	2 Home Players Rod	1
	R5	5 Away Players Rod	1
	R6	3 Away Players Rod	2
	R7	2 Away Players Rod	1

ASSEMBLY INSTRUCTIONS

SOCGER TABLE ASSEMBLY

WARNING: Two adults needed to assemble soccer table

14. Insert the player rods **C1&C2&C3** through one side panel, then insert players **C8&C9**, rubber bushings **C4**, plastic washers **C5** through the rod, refer to **R1~R7**. then insert the player rod through other side panel, attach the players **C8&C9** with bolts **C6** and nuts **C7**. See **Figure 5**.
15. Slide the handles **P8** onto the end of the rods with bolt **H10**.
Slide the rod end caps **P9** onto the other end of the rods.

Tighten all the hardware before playing games !

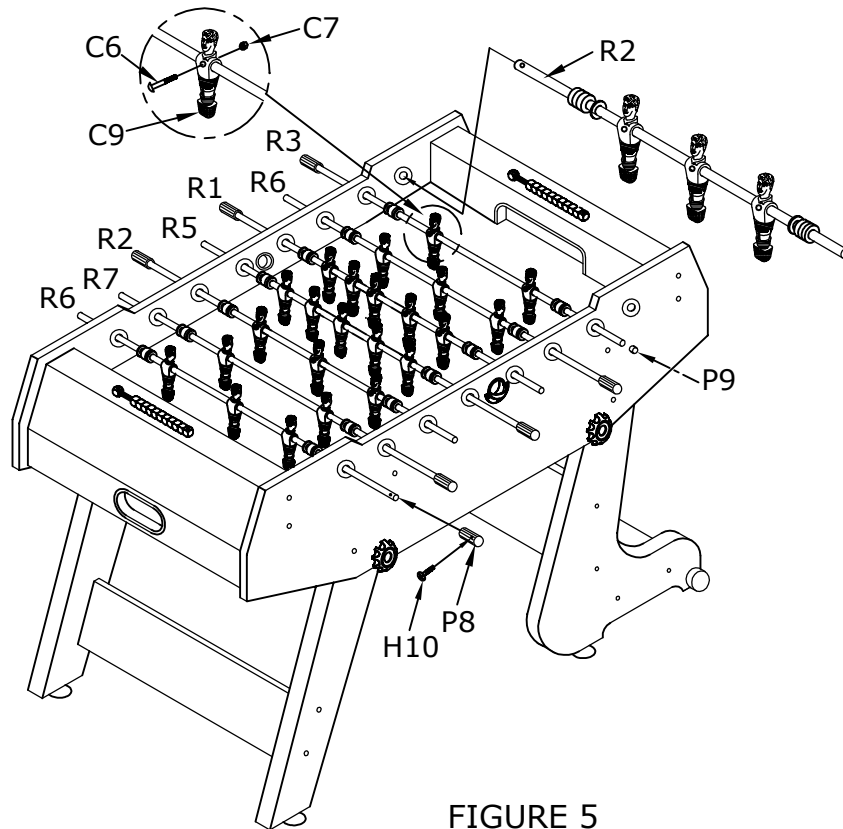
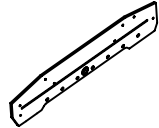

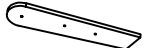

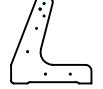
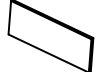







FIGURE 5





PARTS IDENTIFIER

ASSEMBLY PARTS

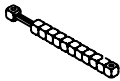
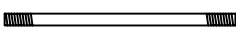

	DESCRIPTION	QTY.
 P1	SIDE PANEL	2
 P2	END PANEL	2
 P3	PLAYING FIELD	1
 P4A	LEFT STRAIGHT LEG	1
 P4B	RIGHT STRAIGHT LEG	1
 P5A	LEFT ANGLED LEG	1
 P5B	RIGHT ANGLED LEG	1
 P6	LEG PANEL	3
 P7	PLAYFIELD SUPPORT BRACE	3
 P8	HANDLE	8
 P9	ROD END CAP	8
 P10A	BALL ENTRY CUP	2
 P10B	BALL ENTRY SOCKET	2
 P11	SUPPORT BRACKET	2

PARTS IDENTIFIER

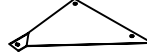
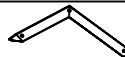
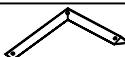
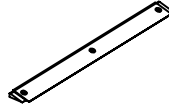
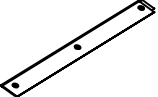
ASSEMBLY PARTS

	DESCRIPTION	QTY.
 P12	SLIDE SCORER	2
 P13	28-1/2" BOLT	3
 P14A	PLASTIC CASTER A	2
 P14B	PLASTIC CASTER B	2
 P15	LEG LEVELER	4
 #1a	TRIANGLE a	2
 #1b	TRIANGLE b	2
 #2a	L STYLE PLASTIC a	2
 #2b	L STYLE PLASTIC b	2
 #3a	LONG PLASTIC a	2
 #3b	LONG PLASTIC b	2

ACCESSORIES

	DESCRIPTION	QTY.
 A1	Soccer Ball	6
 A2	Tool	2

ASSEMBLY INSTRUCTIONS

SOCCER TABLE ASSEMBLY

WARNING: Two adults needed to assemble soccer table

- Attach the ball entry cup **P10A** and ball entry cup socket **P10B** to the side panel using screws **H8** as shown in **FIGURE 4**.
- Attach the scorer **P12** to the end panel with **H9** as shown in **FIGURE 4**.
- Attach the plastic **#2a, #2b, #3a, #3b**, to the Playing Field with **S1** as shown in **FIGURE 4**.

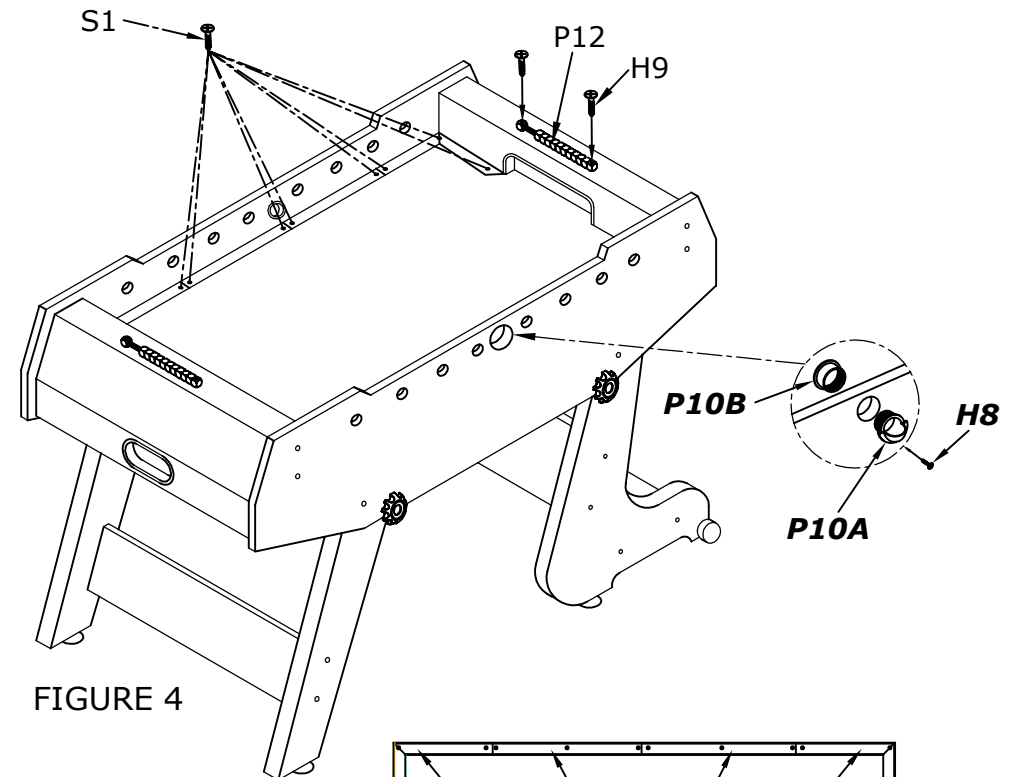

FIGURE 4

Play surface
TOP VIEW

ASSEMBLY INSTRUCTIONS

SOCCER TABLE ASSEMBLY

WARNING: Two adults needed to assemble soccer table

5. Attach the straight legs **P4A&P4B** and angled legs **P5A&P5B** to the table by using bolts **H1**, washers **H5** and handle nuts **H12** as shown in **FIGURE 3**.
6. Screw the support bracket **P11** into place using screws **H8** as shown in **FIGURE 3**.
7. Insert the nut **H11** into the hole of the leg panel **P6** as shown in **FIGURE 3**.
the hole of the nut align the hole of the panel.
8. Attach the leg panels **P6** to the straight legs and angled legs with bolts **H2** and washers **H6** as shown in **FIGURE 3**.
9. Insert the leg caster (**P14A**) & (**P14B**) through the predrilled hole in the extremity of the leg.
10. Attach the leg levelers **P15** as shown in **FIGURE 3**.

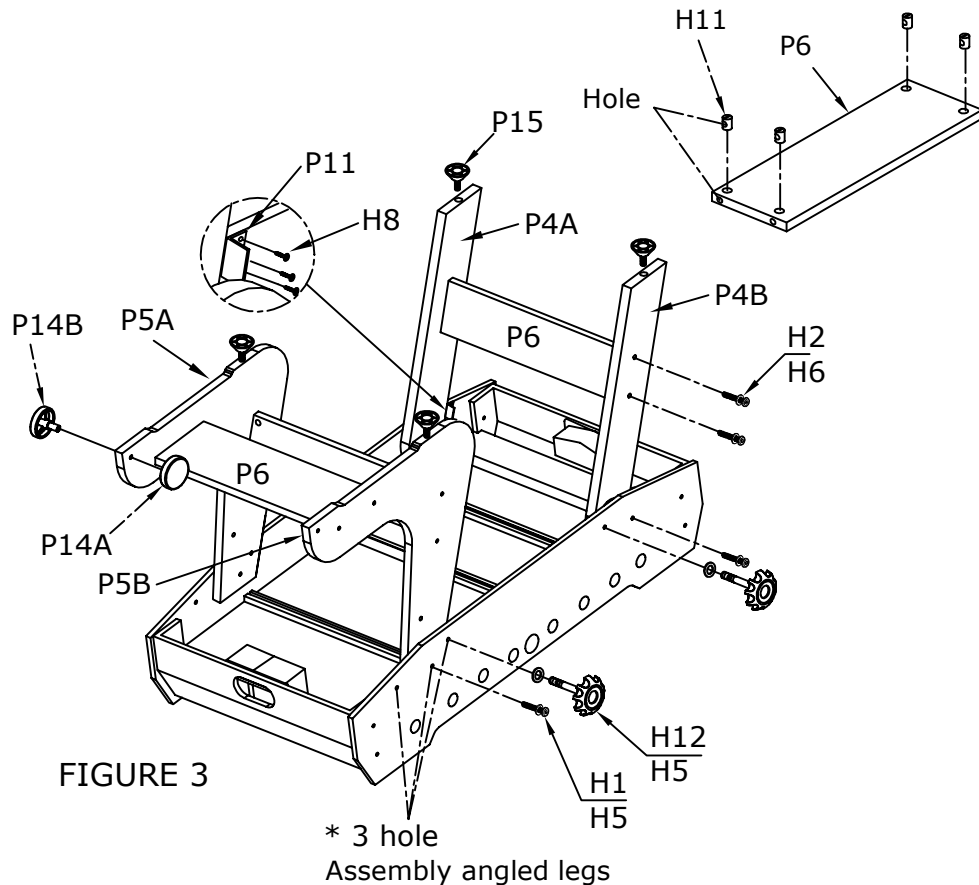
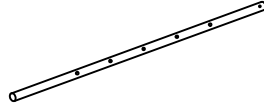
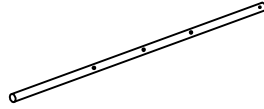
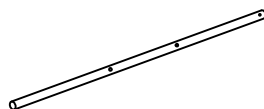

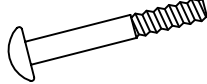





FIGURE 3

PARTS IDENTIFIER

REPLACEMENT PARTS

	DESCRIPTION	QTY.
 C1	5 Player Rod	2
 C2	3&1 Player Rod	4
 C3	2 Player Rod	2
 C4	Ruber Bushing	16
 C5	Plastic Rod Washer	16
 C6	5/32" x 1" Bolt (used to install men)	26
 C7	5/32" Lock Nut (used to install men)	26
 C8	Away Men	13
 C9	Home Men	13

ASSEMBLY INSTRUCTIONS

SOCCER TABLE ASSEMBLY

WARNING: Two adults needed to assemble soccer table

1. Insert playing field **P3** into the groove on the side panels **P1** with graphics facing down. See **FIGURE 1**.
2. Place the playfield support braces **P7** on the bottom of the playfield.
Insert support rods **P13** through the hole in the side panel **P1** and the groove in the playfield support braces **P7** as shown in **FIGURE 1**.
Place washers **H4** and lock nuts **H3** on each end of support rods **P13**.

CAUTION:
Do not over-tighten hardware!

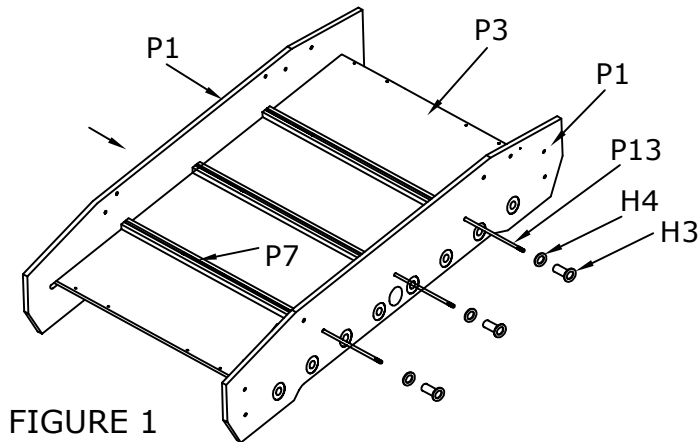

ASSEMBLY INSTRUCTIONS

SOCCER TABLE ASSEMBLY

WARNING: Two adults needed to assemble soccer table

3. Attach the two end panels **P2** to the side panels **P1** with bolts **H2** and washers **H6** as shown in **FIGURE 2**.
4. Attach the playing field in the panels with screws **H7** as shown in **FIGURE 2**.

