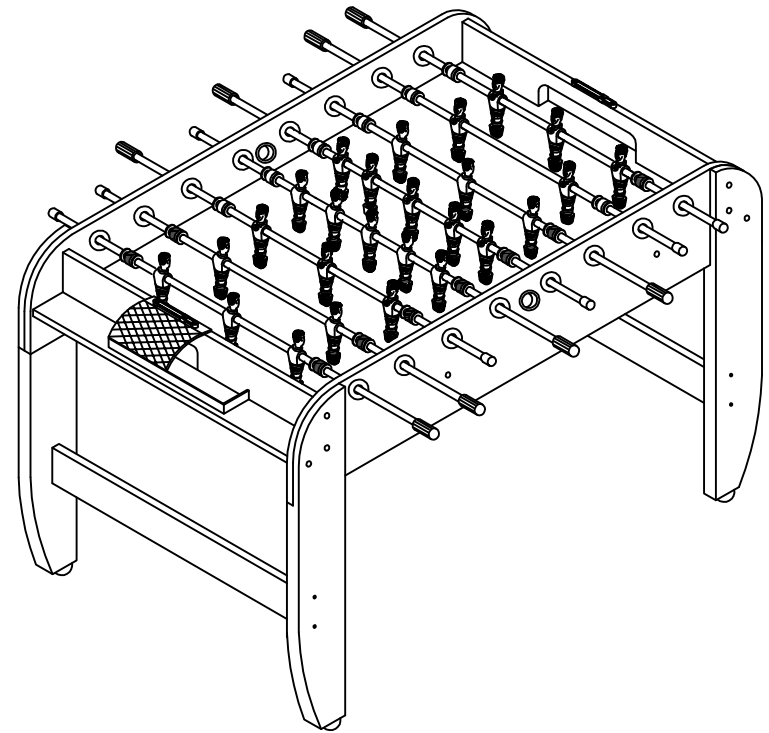

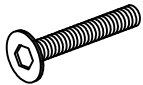

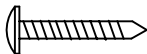

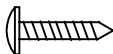
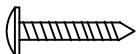

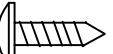

TABLE SOCCER

ASSEMBLY INSTRUCTIONS



PARTS IDENTIFIER

HARDWARE

	DESCRIPTION	QTY.
	H1 1/4" X 2-1/4" BOLT	12
	H2 1/4"WASHER	12
	H3 2-1/2" ROUND HEAD SCREW	8
	H4 1/2" ROUND HEAD SCREW	6
	H5 5/8" ROUND HEAD SCREW	4
	H6 1-1/4" ROUND HEAD SCREW	6
	H7 1-1/2" ROUND HEAD SCREW	4
	H8 CYLINDRICAL NUT(Plastic)	12
	H9 CYLINDRICAL NUT(Metal)	12
	H10 SCREW(used to install handle)	8
	S1 1/2"FLAT HEAD SCREW	24

ACCESSORIES

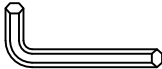
	DESCRIPTION	QTY
	A1 SOCCER BALL	2
	A2 TOOL	1

ASSEMBLY INSTRUCTIONS

SOCCER TABLE ASSEMBLY

WARNING: TWO ADULTS NEEDED TO ASSEMBLE SOCCER TABLE

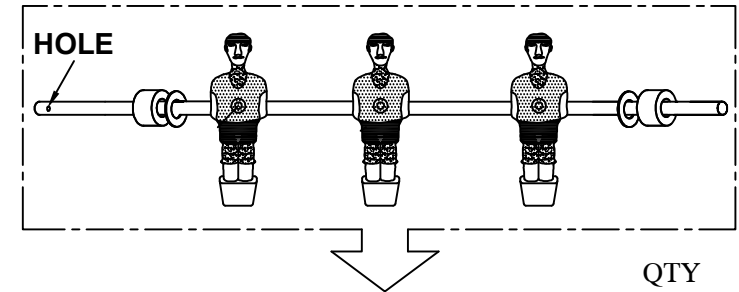

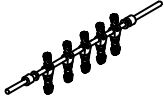
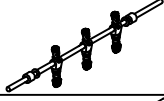
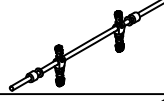
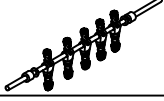
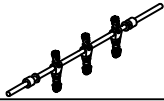
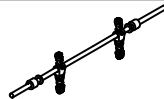
	R1 5 HOME PLAYERS ROD	1
	R2 3 HOME PLAYERS ROD	2
	R3 2 HOME PLAYERS ROD	1
	R4 5 AWAY PLAYERS ROD	1
	R5 3 AWAY PLAYERS ROD	2
	R6 2 AWAY PLAYERS ROD	1

ASSEMBLY INSTRUCTIONS

SOCCER TABLE ASSEMBLY

WARNING: TWO ADULTS NEEDED TO ASSEMBLE SOCCER TABLE

- 6 INSERT THE PLAYER RODS **C1&C2&C3** THROUGH ONE SIDE PANEL, THEN INSERT PLAYERS **C8&C9** AND RUBBER BUSHINGS **C4**, PLASTIC WASHERS **C5** THROUGH THE ROD, REFER TO **R1~R6**. THEN INSERT THE PLAYER ROD THROUGH OTHER SIDE PANEL, ATTACH THE PLAYERS **C8&C9** WITH BOLTS **C6** AND NUTS **C7**. SEE **Figure 6**.
- 7 ATTACH THE HANDLES **P7** WITH BOLT **H10**. SLIDE THE RUBBER CAPS **P8** ON THE OTHER END OF THE ROD.
- 8 ATTACH THE TWO BALL CATCHER TO THE END PANEL WITH SCREW **H4**. ATTACH THE TWO SETS OF SLIDE SCORER **P9** TO THE END OF TABLE WITH SCREWS **H5**. SEE **FIGURE 6**.

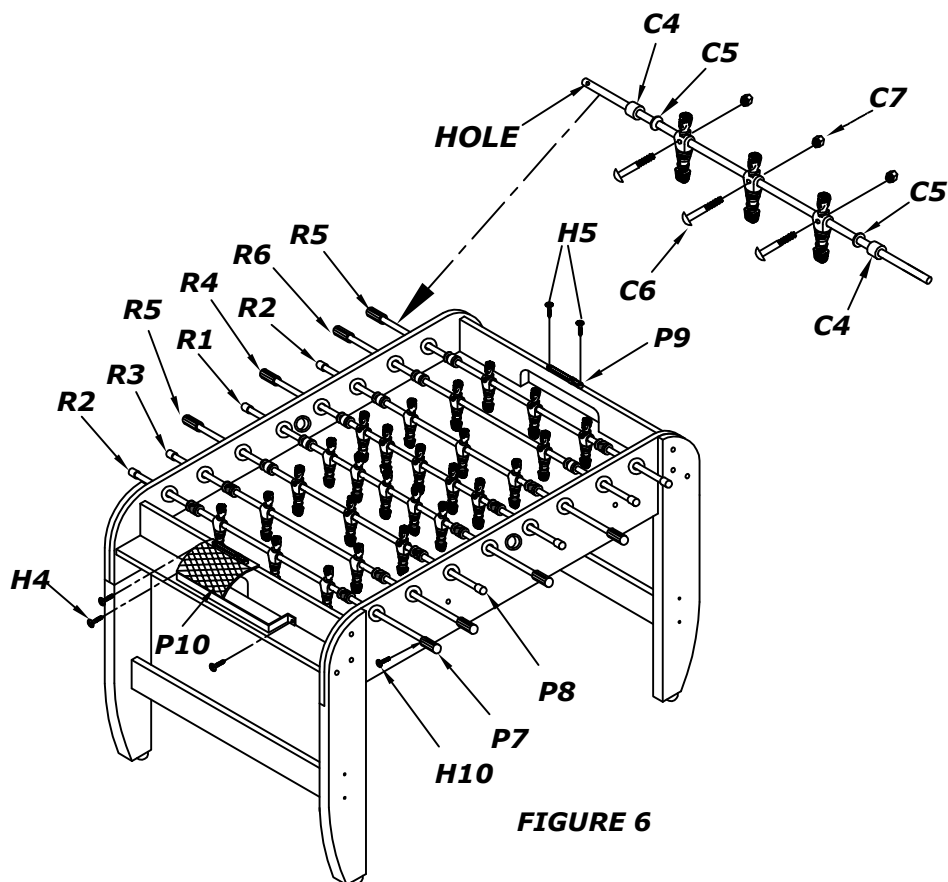
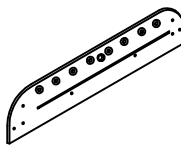

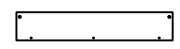
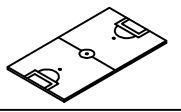
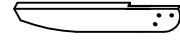
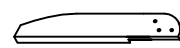
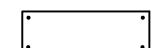



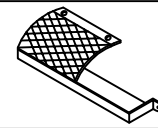



FIGURE 6

PARTS IDENTIFIER

ASSEMBLY PARTS

	DESCRIPTION	QTY. REQUIRED (EXTRA PIECES MAY BE INCLUDED)
	P1 SIDE PANEL	2
	P2A END PANEL (A)	2
	P2B END PANEL (B)	2
	P3 PLAYING FIELD	1
	P4A LEG A	2
	P4B LEG B	2
	P5 LEG PANEL	2
	P6 PLAYFIELD SUPPORT BRACE	2
	P7 ROD HANDLE	8
	P8 ROD END CAP	8
	P9 SLIDE SCORER	2
	P10 BALL CATCHER	2
	P11 LEG LEVELER	4

PARTS IDENTIFIER

ASSEMBLY PARTS

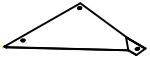
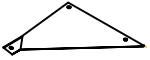
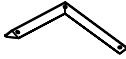
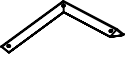
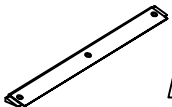
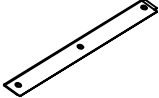
	DESCRIPTION	QTY
	#1a TRIANGLE a	2
	#1b TRIANGLE b	2
	#2a L STYLE PLASTIC a	2
	#2b L STYLE PLASTIC b	2
	#3a LONG PLASTIC a	2
	#3b LONG PLASTIC b	2

ASSEMBLY INSTRUCTIONS

SOCCER TABLE ASSEMBLY

WARNING: TWO ADULTS NEEDED TO ASSEMBLE SOCCER TABLE

- ATTACH THE PLASTIC **#2a, #2b, #3a, #3b**, TO THE PLAYING FIELD WITH **S1** AS SHOWN IN **FIGURE 5**.

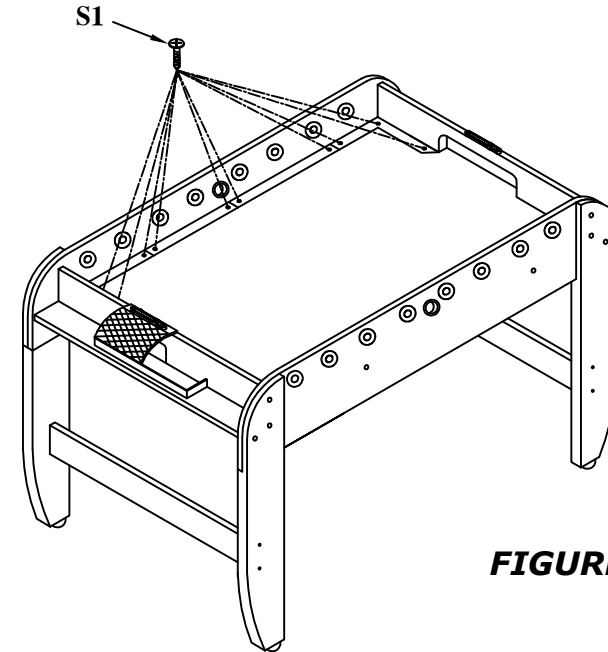
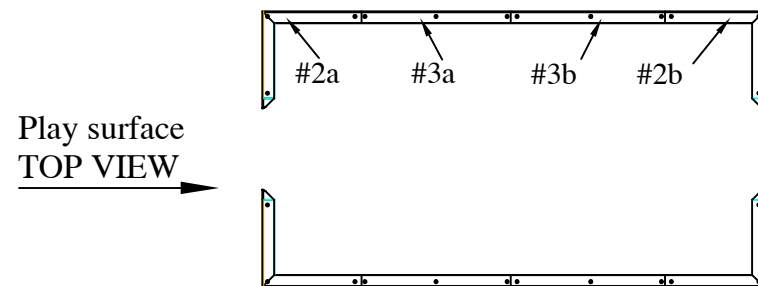

FIGURE 5



ASSEMBLY INSTRUCTIONS

SOCCER TABLE ASSEMBLY

WARNING: TWO ADULTS NEEDED TO ASSEMBLE SOCCER TABLE

- 3 INSERT THE NUT **H8** INTO THE HOLE OF THE SUPPORT BRACES **P6** AS SHOWN IN **FIGURE 4**. THE HOLE OF THE NUT ALIGN THE HOLE OF THE BRACES.

PLACE THE PLAYFIELD SUPPORT BRACES **P6** ON THE BOTTOM OF THE PLAYFIELD. AND ATTACH IT WITH SCREWE **H7** AS SHOWN IN **figure 4**.

- 4 INSERT THE NUT **H8** INTO THE HOLE OF THE LEG PANELS **P5**. THE HOLE OF THE NUT ALIGN THE HOLE OF THE PANLE, ASSEMBLE THE LEG PANELS **P5** BY USING SCREWS **H3** AS SHOWN IN **figure 4**.

ATTACH THE LEG LEVELERS **P11** AS SHOWN IN figure 4.

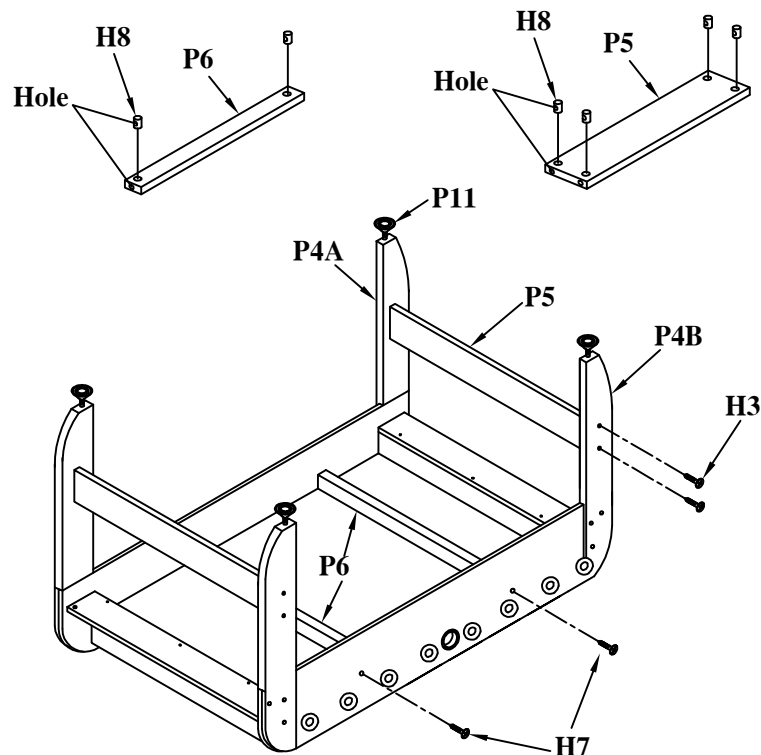
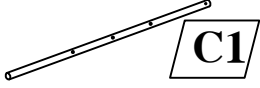
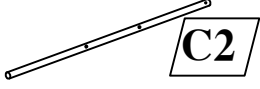
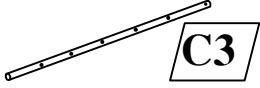

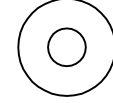
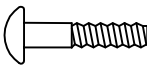





FIGURE 4

PARTS IDENTIFIER

ASSEMBLY PARTS

	DESCRIPTION	QTY
 C1	3 PLAYER ROD	4
 C2	2 PLAYER ROD	2
 C3	5 PLAYER ROD	2
 C4	RUBBER BUSHING	16
 C5	PLASTIC ROD WASHERS	16
 C6	Bolt (used to install men)	26
 C7	NUT	26
 C8	AWAY MEN	13
 C9	HOME MEN	13
 C10	ROD BUSHING	32

ASSEMBLY INSTRUCTIONS

SOCCER TABLE ASSEMBLY

WARNING: TWO ADULTS NEEDED TO ASSEMBLE SOCCER TABLE

- 1 SLIDE PLAYFIELD **P3** INTO THE GROOVE ON THE SIDE PANELS **P1** WITH GRAPHICS FACING DOWN. SEE **figure 1**.

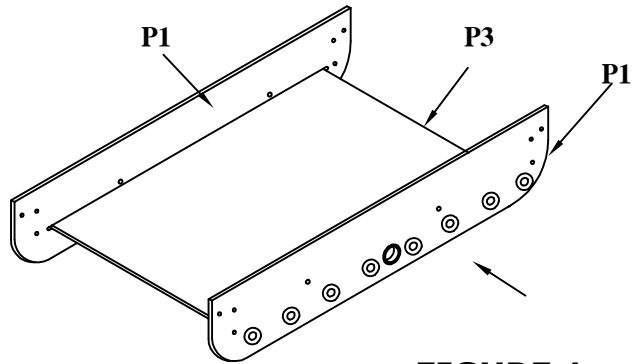

FIGURE 1

ASSEMBLY INSTRUCTIONS

SOCCER TABLE ASSEMBLY

- 2 INSERT THE NUT **H9** INTO THE HOLE OF THE END PANELS **P2A** AND **P2B**, THE HOLE OF THE NUT ALIGN THE HOLE OF THE PANLE. ATTACH THE TWO END PANELS WITH SCREW **H6**. SEE **FIGURE 2**. ATTACH THE TWO END PANELS AND FOUR LEGS TO THE SIDE PANELS **P1** WITH **H1&H2**. SEE **FIGURE 3**.

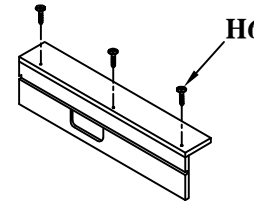
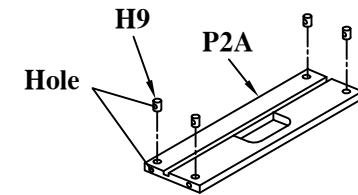
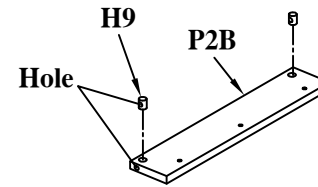

FIGURE 2

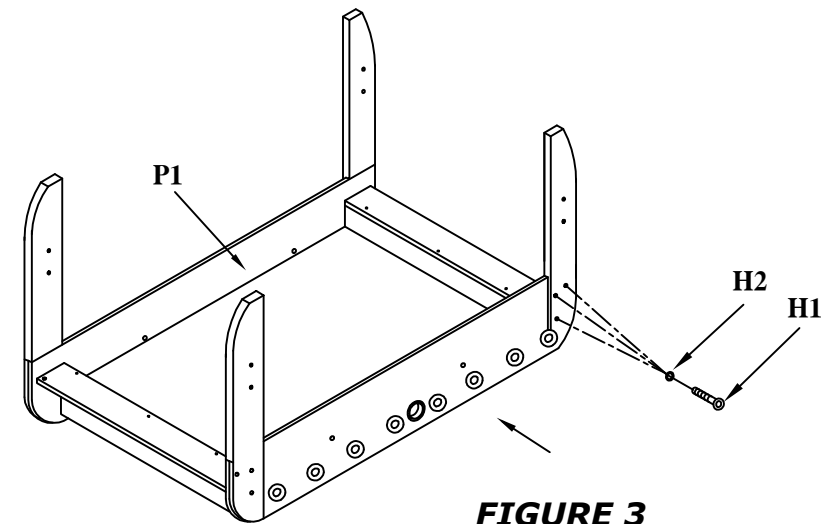

FIGURE 3